

nopa[®] instruments



surgical
emergency set

nopa emergency set was put together with the intention to support live-saving emergency operations caused by gunshots, explosions or for crisis situations. When it comes to a mass casualty incident (attack, rampage, crisis situations, etc.) the survival depends on rapid bleeding control.

For this purpose, this set contains surgical instruments to treat heavily bleeding wounds in the chest, abdomen and pelvic cavity.

field of applications

- + **emergency cases in crisis areas**
- + **mass casualty incidents**
- + **terrorist attacks**
- + **crisis situations**

benefits

- + **only one set needed for many surgical interventions**
- + **needed surgical instruments in one package fast at hand**
- + **easy transportation**
- + **space saving**
- + **German proved quality**

We expressly point out that the products shown/mentioned may only be used and operated by trained specialist personnel with the appropriate qualifications, and for the proper, intended and prescribed purpose as specified in the operating instructions. Improper and/or non-prescribed use of the products may lead to serious and undesirable consequences as well as complications.

Wir weisen ausdrücklich darauf hin, dass die gezeigten / genannten Produkte nur von ausgebildetem Fachpersonal mit entsprechender Qualifikation und unter der Voraussetzung des sachgemäßen, zweckbestimmten und bestimmungsgemäßen Gebrauchs, laut Angaben der Bedienungsanleitung verwendet und eingesetzt werden dürfen. Unsachgemäße und die nicht bestimmungsmäßige Verwendung der Produkte, kann zu schwerwiegenden und unerwünschten Folgen, sowie Komplikationen führen.

SET

suggested instrument set

ZS 112/01

Art.No.	Description	Qty.	Art.No.	Description	Qty.
AA 151/12	HALSTED-MOSQUITO FCPS CVD. 12.5 CM	4	KD 250/25	KOCHER AT INTEST. CLAMP FCPS. STR. 25.0 CM	2
AA 153/12	HALSTED-MOSQUITO FCPS. 1X2 CVD. 12.5 CM	2	KK 027/32	BRUNNER RIB SHEARS RIGHT HAND 32.0 CM	1
AA 210/14	OCHSNER-KOCHER FCPS. STR. 14.0 CM	2	KK 040/25	LEBSCHER CHISEL 25.0 CM	1
AA 223/01	OVERHOLT-GEISSENDOERFER FIG. 1 27.0 CM	8	KK 120/02	BURFORD RIB SPREADER 250 MM	1
AA 229/04	OVERHOLT ART.FCPS S-SHAPED 21.5 CM	2	KK 180/32	ALLISON LUNG SPATULA 32.0 CM	1
AA 348/18	BABY-MIXTER ART. FCPS CVD. 18.0 CM	2	KK 350/10	DE BAKEY ATRAUMA BULLD. CLAMP STR. 10.5 CM	2
AA 611/20	MIKULICZ PERIT. CLAMP-FCPS HEAVY 20.5 CM	2	KK 351/10	DE BAKEY ATRAUMA BULLD. CLAMP CVD. 10.0 CM	2
AB 060/16	STANDARD TISSUE FCPS. 1X2 T STR. 16.0 CM	2	KK 373/07	DE BAKEY-SATINSKY BULLD. CLAMP	1
AB 060/25	STANDARD TISSUE FCPS. 1X2 T STR. 25.0 CM	2	KK 373/10	DE BAKEY-SATINSKY BULLD. CLAMP	1
AB 160/18	GERALD DRESSING FORCEPS STR. 18.0 CM	2	KS 102/50	OLIVECRONA-GIGLI WIRE SAW 2X 50.0 CM	1
AB 862/24	DE BAKEY FCPS. STR. 2.0 MM 24.0 CM	2	KS 120/00	HOOK HANDLE FOR WIRE SAW / 1 PAIR	1
AB 864/30	DE BAKEY ATRAUMA FCPS. STR. 2.8 MM 30.0 CM	2	KU 302/25	KIDNEY TRAY 250 MM, 850 ML	1
AC 101/14	METZENBAUM SCISSORS CVD. BL/BL 14.5 CM	1	KU 307/23	UNIVERSAL TRAY 230 X 155 X 30 MM	1
AC 111/23	METZENBAUM-NELSON SCS. CVD. BL/BL 23.0 CM	1	KYE 280/53	LID PERFORATED 580 X 280 MM, RED	1
AC 111/28	METZENBAUM-NELSON SCS. CVD. BL/BL 28.0 CM	1	KYE 287/15	BOTTOM NON PERFORATED, 580 X 280 X 150 MM	1
AC 215/15	REYNOLDS DISS.SCISSORS CVD. SHARP 15.0 CM	1	SK 307/07	WIRE BASKET, 535 X 245 X 70 MM	2
AC 219/60	POTTS-SMITH ART. SCS. 60 DEGREE 19.0 CM	1	SX 460/02	CLOTH GREEN 85 X 85 CM	1
AC 551/18	UNIVERSAL BANDAGE SCISSORS 18.0 CM	1			
AC 801/15	DISSECTION MICRO SCISSORS BL/BL 14.5 CM	1			
AC 870/03	MICRO SCISSORS 18.0 CM, 60°	1			
AD 020/13	SCALPEL HANDLE NO.3 L	1			
AE 400/20	MAYO-HEGAR NEEDLE HOLDER TUC 20.0 CM	1			
AE 420/20	DE BAKEY NEEDLE HOLDER TUC 20.0 CM	1			
AE 420/26	DE BAKEY NEEDLE HOLDER TUC 26.0 CM	1			
AE 482/27	MASSON NEEDLE HOLDER TUC 27.0 CM	1			
AE 552/18	WIRE TWISTING FORCEPS TUC 18.5 CM	1			
AE 630/18	MICRO-NEEDLE HOLDER STR. RA 18.0 CM	1			
AF 100/25	GROSS-MAIER DRESSING FCPS. STR 25.0 CM	2			
AF 101/25	GROSS-MAIER DRESSING FCPS. CURVED 25.0 CM	4			
AK 102/18	CUSHING RETRACTOR 18 MM 24.0 CM	2			
AK 290/01	MIKULICZ RETRACTOR 85 X 35 MM 26.0 CM	2			
AK 290/02	MIKULICZ RETRACTOR 120 X 50 MM 26.0 CM	2			
AK 290/03	MIKULICZ RETRACTOR 155 X 50 MM 26.0 CM	2			
AK 350/00	ROUX RETRACTOR SET FIG. 1-3	1			
AO 820/10	GUIDE NEEDLE 10 CHARR.	1			
AO 820/16	GUIDE NEEDLE 16 CHARR.	1			
KA 172/18	HOHMANN BONE LEVER WIDTH 18MM 24.0 CM	2			
KA 273/17	WIRE FORCEPS 17.0 CM TUC	1			
KA 519/55	OMBREDANNE MALLETS, 550G, 24.0 CM	1			
KA 667/18	RASPATORIES 18.0 CM	1			
KD 058/20	ALLIS AT TISSUE SEIZING FCPS. 20.0 CM	2			

suggested instrument set



HALSTED-MOSQUITO
AA 151/12
12,5 cm/5"

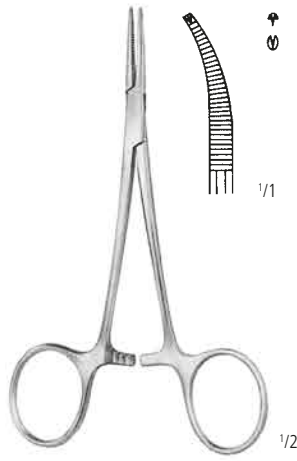

HALSTED-MOSQUITO 1:2
AA 153/12
12,5 cm/5"

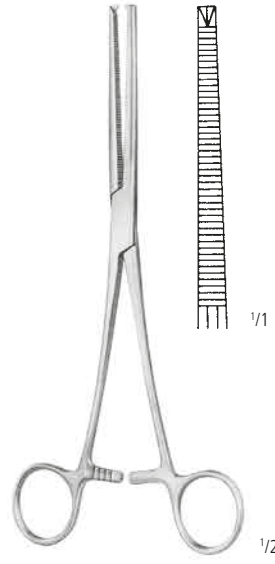

OCHSNER-KOCHER 1:2
AA 210/14
14,0 cm/5 1/2"

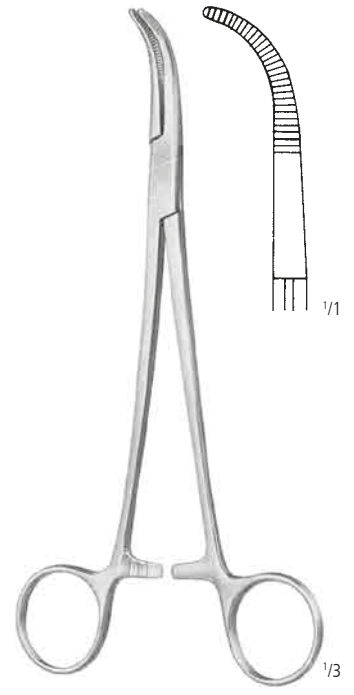

OVERHOLT-GEISSENDOERFER
AA 223/01
27,0 cm/10 3/4"

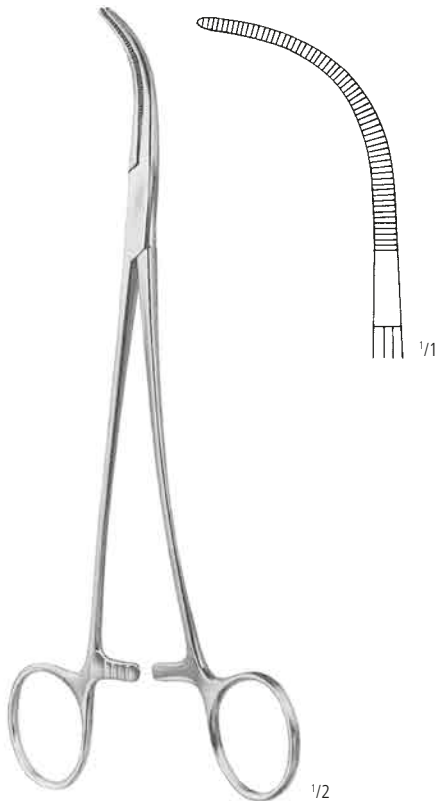

OVERHOLT
AA 229/04
21,5 cm/8 1/2"

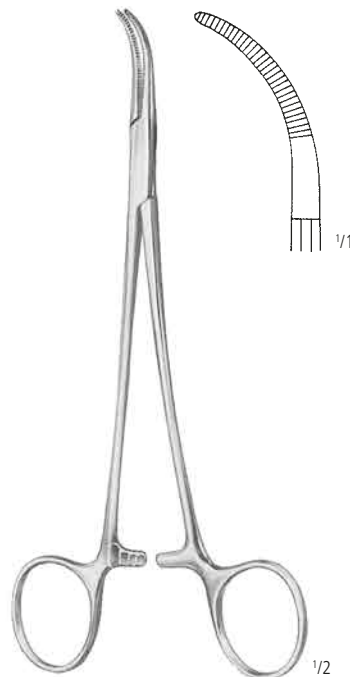

BABY-MIXTER
AA 348/18
18,0 cm/7"

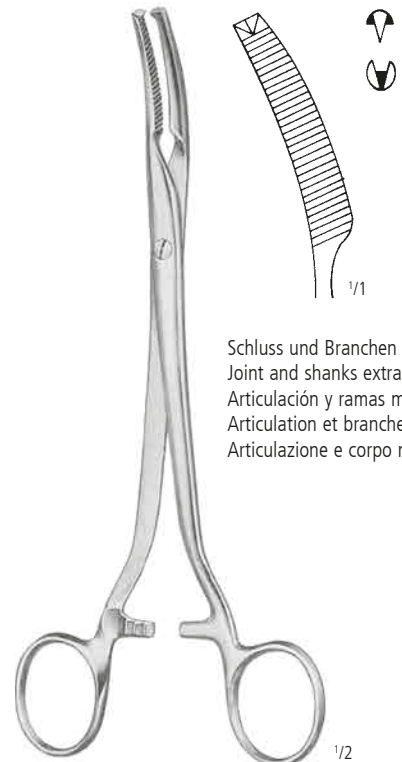

MIKULICZ 1:2
AA 611/20
20,5 cm/8"

Schluss und Branchen extra stark
Joint and shanks extra strong
Articulaci3n y ramas muy fuerte
Articulation et branches tr3s fortes
Articulazione e corpo molto robusto



STANDARD 1:2
AB 060/16
 16,0 cm/6 1/4"

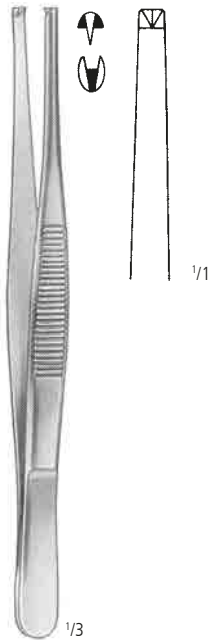

STANDARD 1:2
AB 060/25
 25,0 cm/10"



GERALD
AB 160/18
 18,0 cm/7"

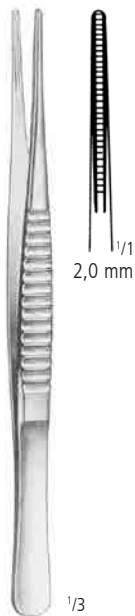

DE BAKEY
AB 862/24
 24,0 cm/9 1/2"

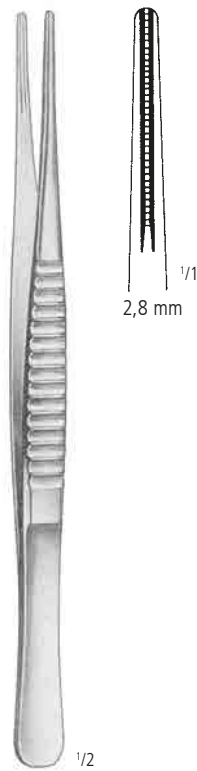

DE BAKEY
AB 864/30
 30,0 cm/12"

Fig. 1
gebogen
curved
curvas
courbes
curve

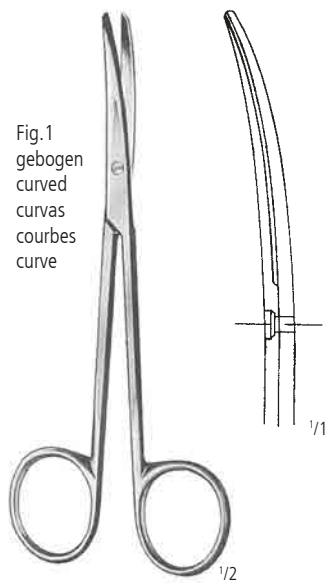

METZENBAUM
AC 101/14
14,5 cm/5³/₄"

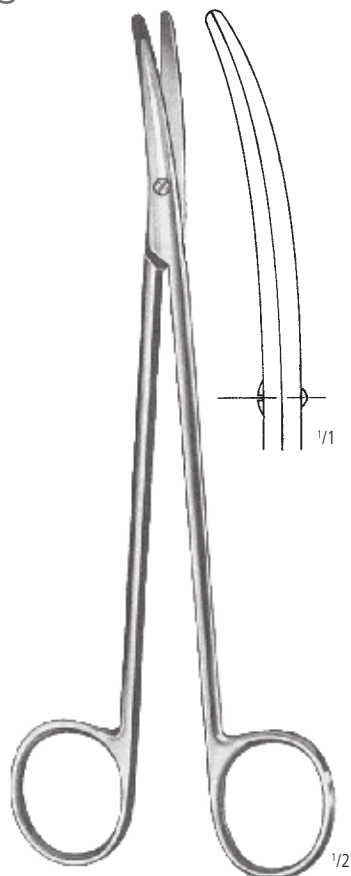

METZENBAUM-NELSON
AC 111/23
23,0 cm/9"

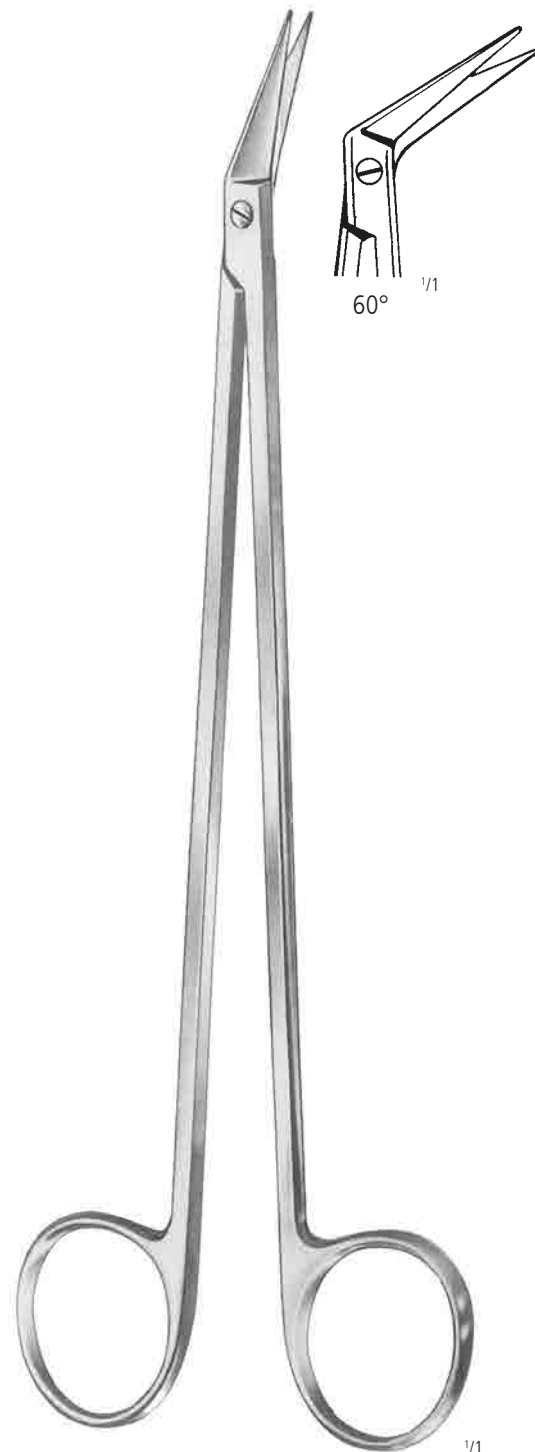

POTTS-SMITH
AC 219/60
19,0 cm/7¹/₂"

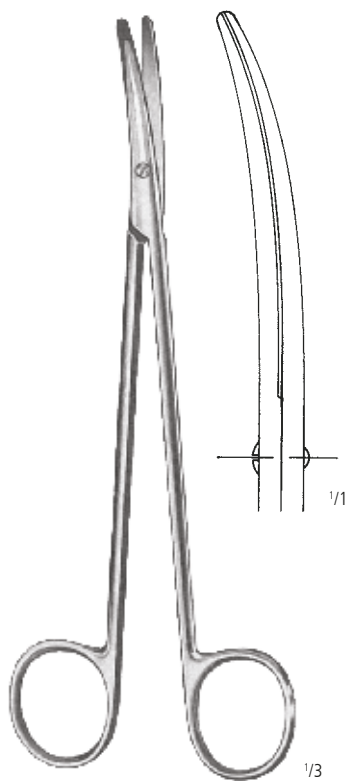

METZENBAUM-NELSON
AC 111/28
28,0 cm/11"

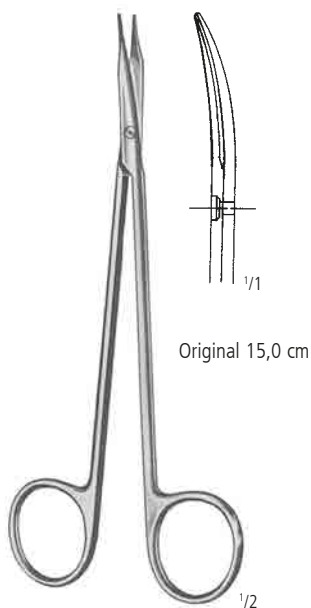

REYNOLDS
AC 215/15
15,0 cm/6"



1/2

UNIVERSAL
AC 551/18
18,0 cm/7"



1/2

Dissection
AC 801/15
14,5 cm/7"



1/1



1/2

AC 870/03
18,0 cm/7"

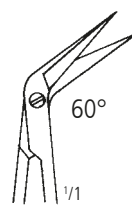

60°

1/1



1/1

AD 020/13
No. 3L



MAYO-HEGAR
AE 400/20
 20,0 cm/8"



DE-BAKEY (MAYO-HEGAR-DELICATE)
AE 420/20
 20,0 cm/8"



DE-BAKEY (MAYO-HEGAR-DELICATE)
AE 420/26
 26,0 cm/10½"



MASSON
AE 482/27
 27,0 cm/10¾"



AE 552/18
 18,5 cm/7¾"



AE 630/18
18,0 cm/7"

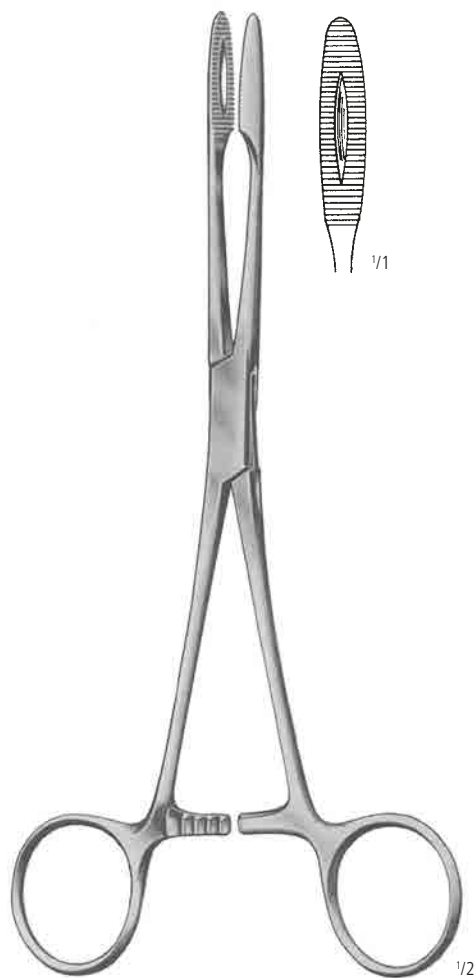

GROSS-MAIER
AF 100/25
25,0 cm/10"

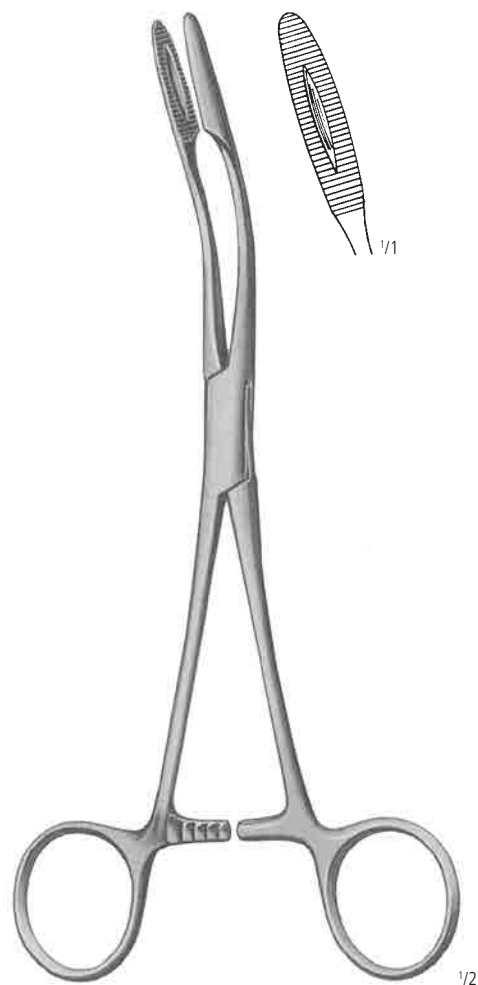

GROSS-MAIER
AF 101/25
25,0 cm/10"



CUSHING
AK 102/18
 24,0 cm/9 1/2"

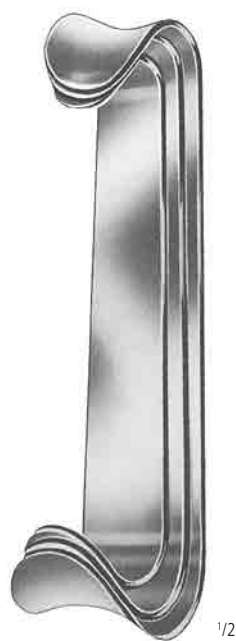
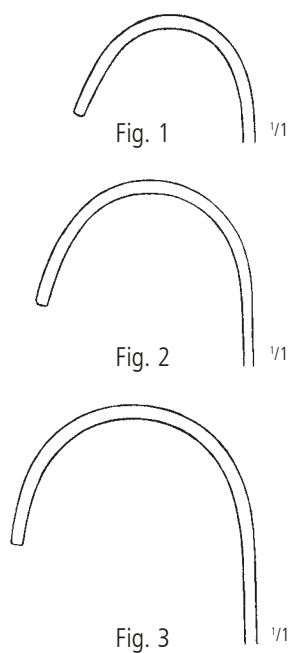

ROUX
AK 350/00
 16,5 cm/6 1/2"
 Fig. 1+2+3



MIKULICZ
 26,0 cm/10 1/2"
 85 x 35 mm **AK 290/01**
 120 x 50 mm **AK 290/02**
 155 x 50 mm **AK 290/03**

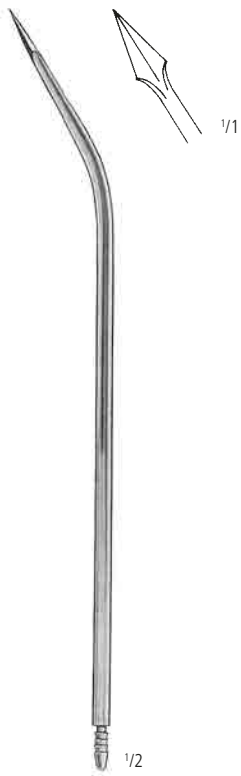

AO 820/10
Charr./Fr.10

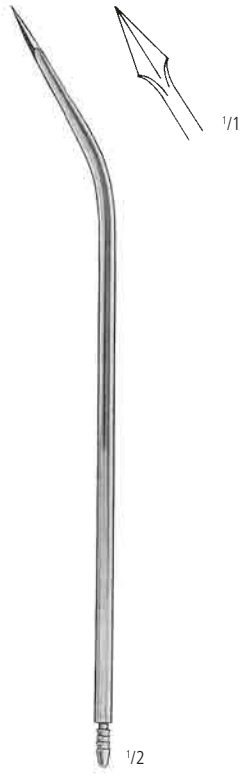

AO 820/16
Charr./Fr.16

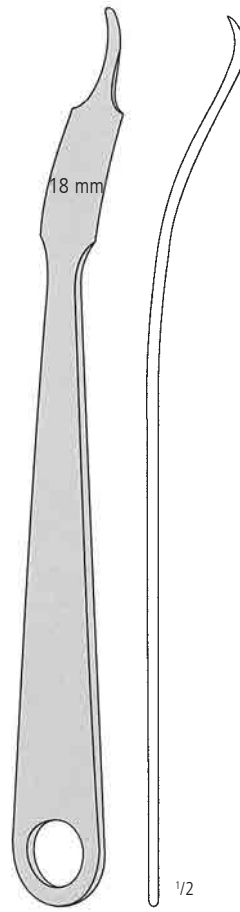

HOHMANN
KA 172/18
24,0 cm/9 1/2"

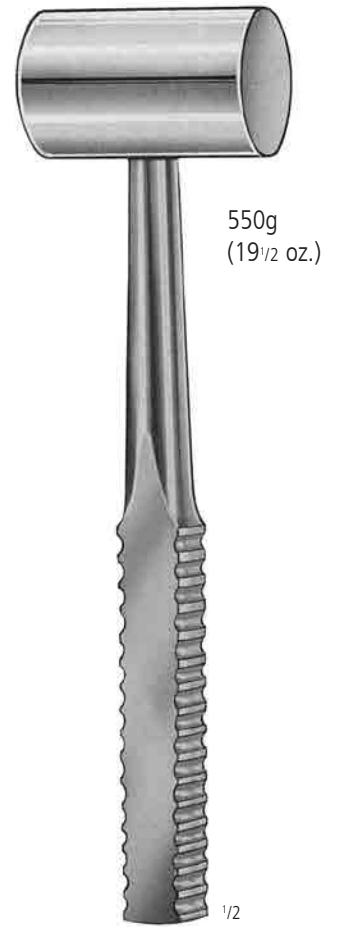

OMBREDANNE
KA 519/55
24,0 cm/9 1/2"



KA 273/17
17,0 cm/6 3/4"



KA 667/18
18,0 cm/7"

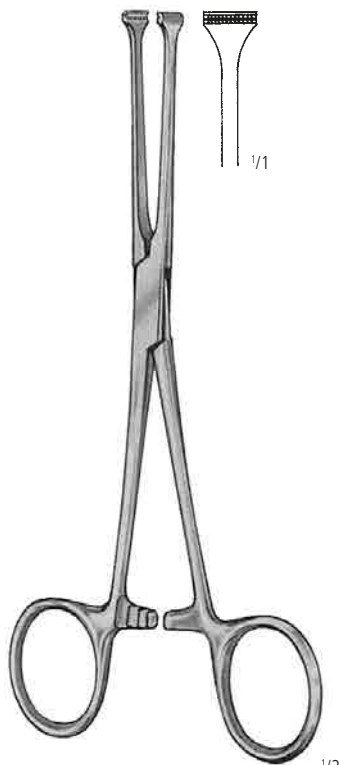

ALLIS
KD 058/20
20,0 cm/8"

1/2

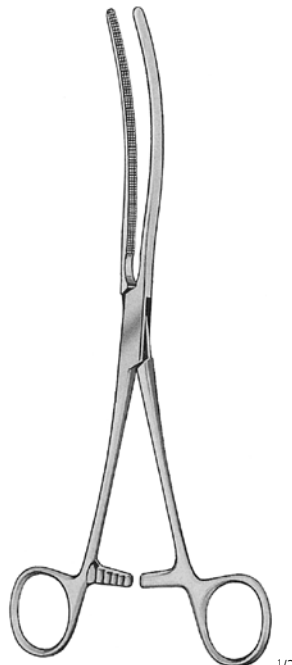

KOCHER
KD 250/25
25,0 cm/10"

1/3

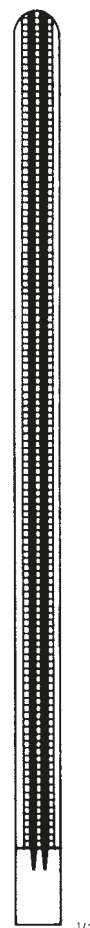

1/1

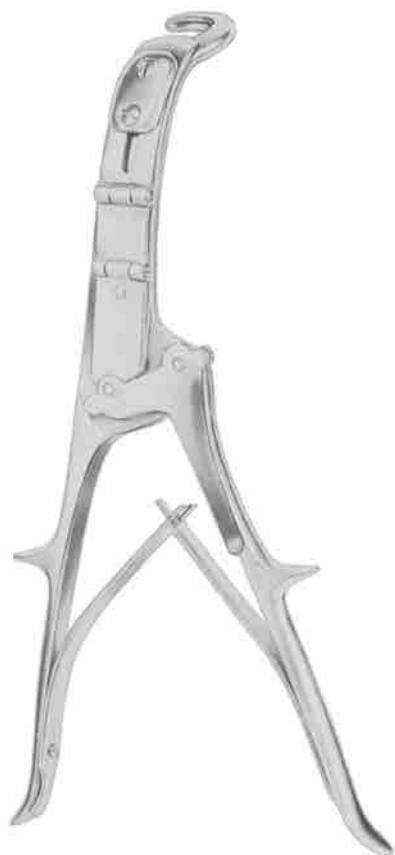

BRUNNER
KK 027/32
32,0 cm/12 1/2"

1/3



LEBSCHE
KK 040/25
25,0 cm/10"

1/3



1/2

ALLISON
KK 180/32
 32,0 cm/12 1/2"



BURFORD
KK 120/02

B	H	C
65 mm	62 mm	
47 mm	62 mm	250 mm



mit 2 Paar Valven
 with 2 pairs of blades
 con 2 pares de valvas
 avec 2 paires des valves
 con 2 paia di valve

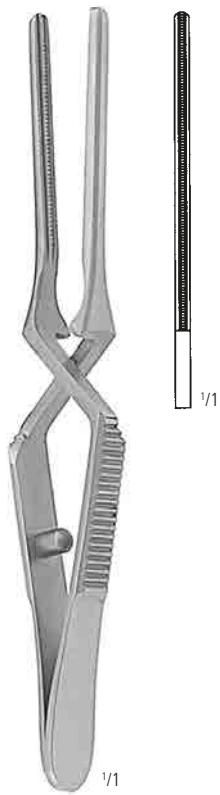

DE BAKEY
KK 350/10
10,5 cm/4¼"

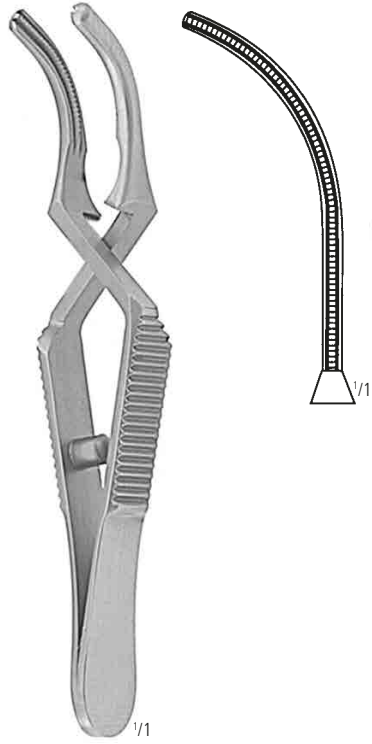

DE BAKEY
KK 351/10
10 cm/4"

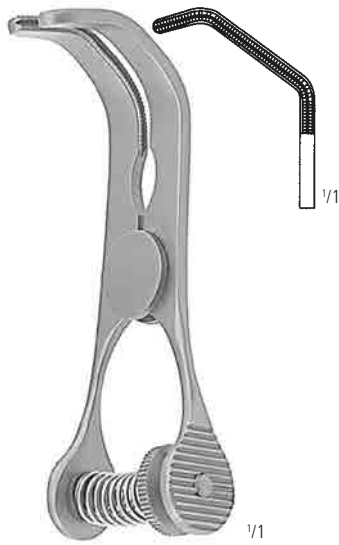

DE BAKEY-SATINSKY
KK 373/07
7,0 cm/2¾"

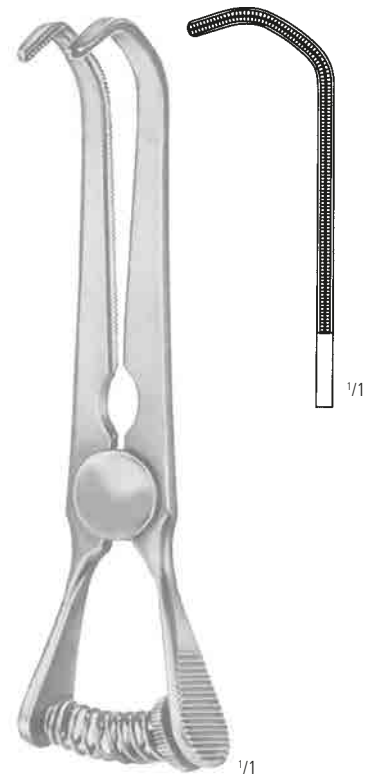

DE BAKEY-SATINSKY
KK 373/10
10,0 cm/4"



KS 102/50
50,0 cm/20"



KS 120/00
Paar / pair / pareja / paire / paio



KU 302/25
l= 250 mm



KU 307/23
l x b x h
230 x 155 x 30 mm



KYE 280/53
L(mm) B(mm)
580 280



KYE 287/15
L(mm) B(mm) H(mm)
580 280 150

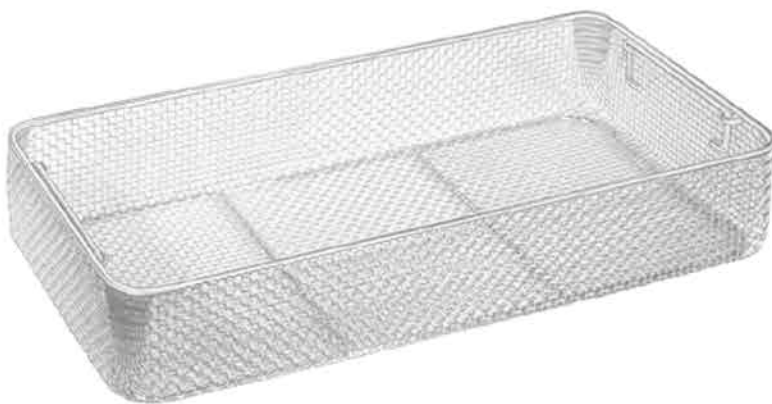

SK 307/07
L(mm) B(mm) H(mm)
540 255 70



SX 460/02
L(cm) B(cm)
85 85

SERVICE PLUS



nopa[®] instruments
traditionally modern

nopa instruments
Medizintechnik GmbH
Weilatten 7-9
78532 Tuttlingen/Germany

Tel. +49 7462 9490-0
Fax +49 7462 9490-90
info@nopa.de
www.nopa.de

Herstellung und Verkauf chirurgischer
und endoskopischer Instrumente.
Manufacture and Sales of Surgical
and Endoscopic Instruments.

