

nopa[®] instruments

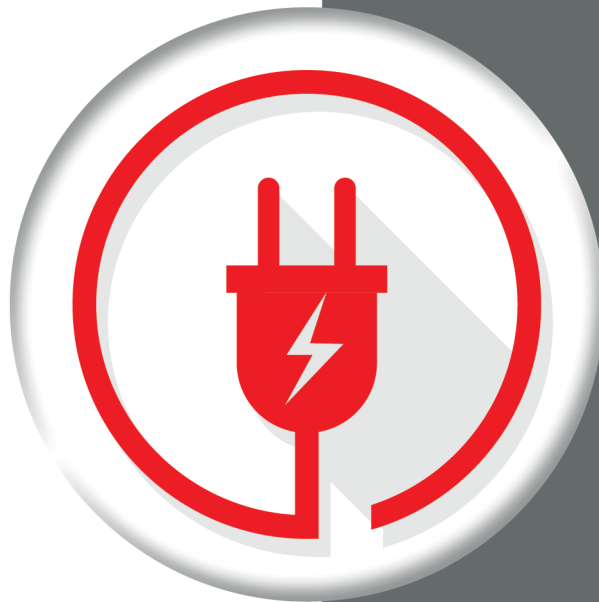

hf-zubehör
hf-accessories
hf-accesorios
hf-accessoires
hf-accessori



Dies ist unser hf-zubehör Katalog, er bleibt unser ausschließliches Eigentum. Es gelten unsere allgemeinen Lieferbedingungen. Sie finden diese auf unserer Internetseite: www.nopa.de

This is our hf-accessories catalogue. It remains our exclusive property. Please find our General Terms of Sale on our corporate website: www.nopa.de

Este es nuestro catálogo hf-accesorios. El catálogo queda nuestra propiedad. Nuestras condiciones generales de venta se encuentran en nuestra página web: www.nopa.de

Voilà notre catalogue hf-accessoires. Il demeure notre propriété. Veuillez consulter nos conditions générales de vente sur notre page Internet: www.nopa.de

Questo è il nostro catalogo hf-accessori. Il catalogo rimane nostra proprietà. Trovate le nostre condizioni generali di fornitura sul nostro sito: www.nopa.de



Wir weisen ausdrücklich darauf hin, dass die gezeigten/genannten Produkte nur von ausgebildetem Fachpersonal mit entsprechender Qualifikation und unter der Voraussetzung des sachgemäßen, zweckbestimmten und bestimmungsgemäßen Gebrauchs, laut Angaben der Bedienungsanleitung verwendet und eingesetzt werden dürfen. Unsachgemäße und die nicht bestimmungsmäßige Verwendung der Produkte kann zu schwerwiegenden und unerwünschten Folgen sowie Komplikationen führen.

We expressly point out that the products shown/mentioned may only be used and operated by trained specialist personnel with the appropriate qualifications, and for the proper, intended and prescribed purpose as specified in the operating instructions. Improper and/or non-prescribed use of the products may lead to serious and undesirable consequences as well as complications.

Señalamos expresamente que los productos mostrados/nombrados sólo pueden ser utilizados y aplicados por personal especializado capacitado y con las debidas calificaciones y bajo la condición de que se haga un uso adecuado, previsto y apropiado, de acuerdo con la información de las instrucciones de funcionamiento. El uso indebido de los productos y su utilización no conforme pueden tener consecuencias y complicaciones graves e indeseables.

Modelländerungen vorbehalten. Nachdruck, auch auszugsweise, verboten.

Change of design and pattern reserved. Re-printing, even in extracts, not permitted.

Nos reservamos el derecho de modificaciones sin aviso previo. Reimpresión, también parcialmente, esta prohibido.

Tous droits réservés aux changements de modèle. Réimprimer, également partiellement, est interdit.

Noi riserviamo il diritto di effettuare delle modificazioni. Ristampa di divieto anche parziale.

Bitte fordern Sie unsere
entsprechenden Kataloge an.

Please request our
appropriate catalogues.

Por favor pida nuestros
catálogos apropiados.

Veillez demander nos
catalogues appropriés.

Vi preghiamo di richiedere
i nostri cataloghi appropriati.

>> Unser Lieferprogramm

Allgemeine Chirurgie
Gynäkologie und Urologie
Hysteroskopie
Zystoskopie
HNO / plastische Chirurgie
Thorax, Herz und Gefäßchirurgie
Neurochirurgie
Ophthalmologie
Endoskopie
Arthroskopie
Container und Sterilisation
Dental und Oral
Podologie

>> Our product range

General Surgery
Gynecology and urology
Hysteroscopy
Cystoscopy
ENT / plastic surgery
Thoracic and cardiovascular surgery
Neurosurgery
Ophthalmology
Endoscopy
Arthroscopy
Container and sterilization
Dental and oral
Podology

**>> Nuestra gama
de productos**

Cirugía general
Ginecología y urología
Histeroscopia
Cistoscopia
ORL / cirugía plástica
Cirugía torácica y cardiovascular
Neurocirugía
Oftalmología
Endoscopia
Artroscopia
Contenedor y esterilización
Odontología y oral
Podología

**>> Notre gamme
des produits**

Chirurgie générale
Gynécologie et urologie
Hystérocopie
Cystoscopie
ORL / chirurgie plastique
Chirurgie thoracique et cardiovasculaire
Neurochirurgie
Ophtalmologie
Endoscopie
Arthroscopie
Conteneur et stérilisation
Dental et oral
Podologie

**>> La nostra gamma
di prodotti**

Chirurgia generale
Ginecologia e urologia
Isteroscopia
Cistoscopia
ORL / chirurgia plastica
Chirurgia toracica e cardiovascolare
Neurochirurgia
Oftalmologia
Endoscopia
Artroscopia
Contentitore e sterilizzazione
Odontoiatria e orale
Podologia



hf-accessories

| | |
|---|-------|
| Elektrodenhandgriffe Electrode handles Mangos porta-electrodos Manches porte-électrodes Mancini porta elettrodi | 7-12 |
| Elektroden Electrodes Electrodos Electrodes Elettrodi | 13-26 |
| Koagulationspinzetten Coagulation forceps Pinzas de coagulación Pinces de coagulation Pinze coagulazione | 27-36 |
| Anschlusskabel & Zubehör Connection cord & accessories Cables de conexión & accesorios Câbles de raccordement & accessoires Cavi da connessione & accessori | 37-41 |





ELEKTRODENHANDGRIFFE
ELECTRODE HANDLES
MANGOS PORTA-ELECTRODOS
MANCHES PORTE-ÉLECTRODES
MANCINI PORTA ELETTRIDI

XR

Elektrodenhandgriffe, ohne Kabel
electrode handles, without cable

8-9

Elektrodenhandgriffe, mit Kabel
electrode handles, with cable

10-12



Elektrodenhandgriffe
 Electrode handles
 Mangos porta-electrodos
 Manches porte-électrodes
 Mancini porta elettrodi

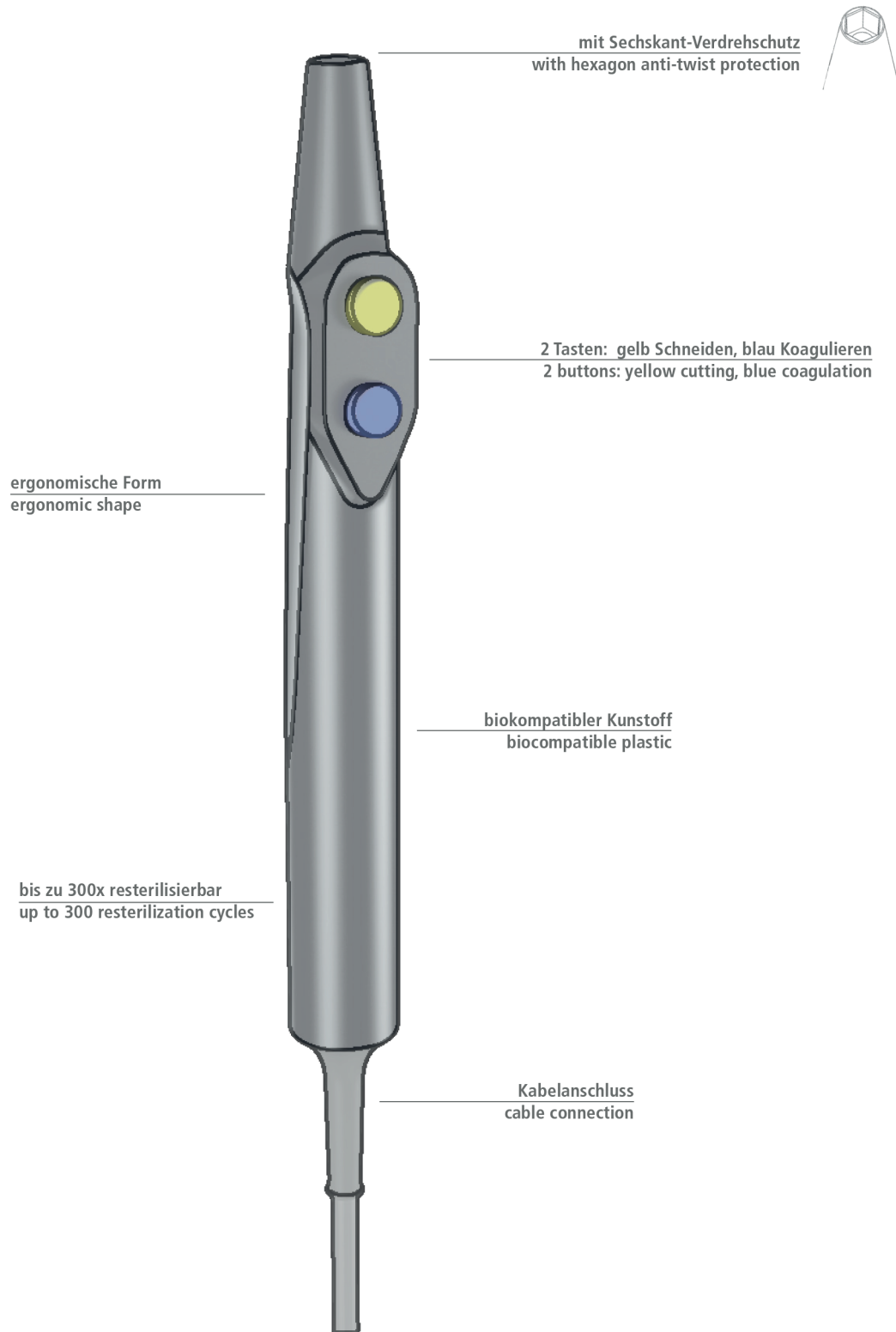

Elektrodenhandgriffe, ohne Kabel
 Electrode handles, without cable
 Mangos porta-electrodos, sin cable
 Manches porte-électrodes, sans câble
 Mancini porta elettrodi, senza cavo

standard-line



| | | |
|----------------------------------|------------------|------------------|
| Erbe ICC/ACC, Storz | XR 800/01 | XR 800/11 |
| Erbe T-Serie | XR 800/03 | — |
| Martin, Berchtold, Integra | XR 800/05 | XR 800/15 |
| passende Kabel suitable cable | 4 m | 5 m |
| Erbe ICC/ACC, Storz | XR 800/50 | XR 800/60 |
| Erbe T-Serie | — | XR 800/63 |
| Martin, Berchtold, Integra | XR 800/55 | XR 800/65 |



Elektrodenhandgriffe, mit Kabel
 Electrode handles, with cable
 Mangos porta-electrodos, con cable
 Manches porte-électrodes, avec câble
 Mancini porta elettrodi, con cavo

standard-line



| | | Länge length | 4.0mm | 2.4mm |
|--|----------------------------|-----------------|------------------|------------------|
| | Erbe ICC/ACC, Storz | 5 m | XR 804/10 | XR 804/50 |
| | Erbe T-Serie | 5 m | XR 804/12 | — |
| | Martin, Berchtold, Integra | 3 m | XR 804/14 | — |
| | | 5 m | XR 804/16 | XR 804/56 |
| | Valleylab, internat. 3 Pin | 3 m | XR 804/18 | XR 804/58 |
| | | 5 m | XR 804/20 | XR 804/60 |

slim-line



| | | Länge length | 4.0mm | 2.4mm |
|--|----------------------------|-----------------|------------------|------------------|
| | Erbe ICC/ACC, Storz | 3 m | XR 805/10 | XR 805/50 |
| | | 5 m | XR 805/12 | XR 805/52 |
| | Erbe T-Serie | 3 m | XR 805/14 | — |
| | Martin, Berchtold, Integra | 3 m | XR 805/16 | XR 805/56 |
| | | 5 m | XR 805/18 | XR 805/58 |
| | Valleylab, internat. 3 Pin | 3 m | XR 805/09 | XR 805/60 |
| | | 5 m | XR 805/22 | XR 805/62 |

Elektrodenhandgriffe, mit Kabel
 Electrode handles, with cable
 Mangos porta-electrodos, con cable
 Manches porte-électrodes, avec câble
 Mancini porta elettrodi, con cavo



4 mm Stecker
 4 mm plug

Länge
 length

5 m



XR 806/10



4 mm Stecker
 4 mm plug

Länge
 length

5 m



XR 806/50

Elektrodenhandgriffe, mit Kabel
 Electrode handles, with cable
 Mangos porta-electrodos, con cable
 Manches porte-électrodes, avec câble
 Mancini porta elettrodi, con cavo



| | | Länge length |  |
|---|----------------------------|-----------------|---|
|  | Erbe ICC/ACC, Storz | 3 m | XR 806/60 |
|  | Martin, Berchtold, Integra | 3 m | XR 806/62 |
|  | 4 mm Stecker 4 mm plug | 3 m | XR 806/64 |
|  | Ellman | 3 m | XR 806/66 |

ELEKTRODEN
ELECTRODES
ELECTRODOS
ÉLECTRODES
ELETTRODI

XR

| | |
|---|-------|
| Universalelektroden, kurz universal electrodes, short | 14-15 |
| Universalelektroden, lang universal electrodes, long | 16-17 |
| Arthroskopieelektroden arthroscopy electrodes | 18-19 |
| Schlingenelektroden wire loop electrodes | 20 |
| Konisationselektroden conisation electrodes | 21 |
| Plastische Chirurgie- und Dentalelektroden plastic surgery & dental electrodes | 22-23 |
| Mikrodissektionsnadelelektroden microdissection needle electrodes | 24-25 |
| Elektrodenverlängerungen electrode extensions | 25 |



Elektroden
Electrodes
Electrodos
Electrodes
Elettrodi

nopa® Elektroden sind für eine Vielzahl verschiedener Einsatzgebiete lieferbar. Dabei können Sie je nach Anforderung zwischen 1,6 mm, 2,4 mm oder 4 mm wählen. Die Elektroden sind am Schaft mit einem Sechskantverdrehschutz ausgestattet.

nopa® electrodes are available for a variety of different applications. Depending on your requirements, you can choose between 1.6 mm, 2.4 mm or 4 mm. Electrodes are equipped with a hexagon anti-twist protection at the shaft.



| | | | |
|--|--|------------------|------------------|
|  | Messerelektrode knife electrode | XR 841/01 | – |
|  | Spatelektrode spatula electrode | XR 841/02 | – |
|  | Lanzettenelektrode lancet electrode | XR 841/04 | XR 842/04 |
|  | Nadelelektrode, Ø 0,7 mm, 15 mm needle electrode, Ø 0,7 mm, 15 mm | XR 841/07 | – |
|  Ø 16 mm | Drahtschlingenelektroden wire loop electrode | XR 841/11 | – |
|  Ø 14 mm | Drahtschlingenelektrode wire loop electrode | – | XR 842/08 |
|  Ø 10 mm | Drahtschlingenelektrode wire loop electrode | XR 841/09 | XR 842/09 |
|  Ø 5 mm | Drahtschlingenelektrode wire loop electrode | XR 841/10 | XR 842/10 |

Elektroden
Electrodes
Electrodos
Electrodes
Elettrodi



Kugelelektrode
ball electrode

XR 843/03

XR 844/03



Kugelelektrode
ball electrode

XR 843/04

XR 844/04



Kugelelektrode
ball electrode

XR 843/05

XR 844/05



Kugelelektrode, abgewinkelt
ball electrode, angular

XR 843/07

XR 844/07





Kugelelektrode, abgewinkelt
ball electrode, angular

XR 843/08

XR 844/08

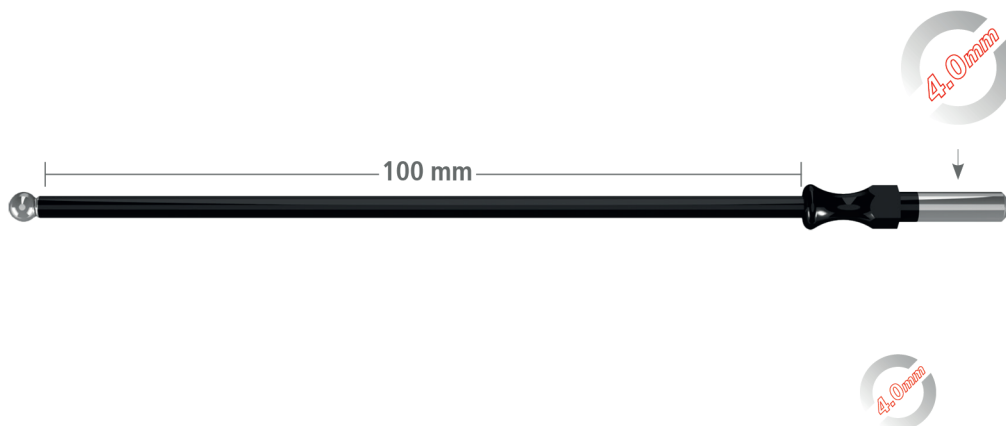
Elektroden
Electrodes
Electrodos
Electrodes
Elettrodi



 Kugelelektrode
ball electrode
Ø 4 mm

XR 845/00

 Messerelektrode, abgewinkelt
knife electrode, angled

XR 845/02

 Messerelektrode, 25 mm x 3,3 mm
knife electrode, 25 mm x 3.3 mm

XR 845/04

 Nadelelektrode, 12 mm x 0,8 mm
needle electrode, 12 mm x 0.8 mm

XR 845/06

Elektroden
Electrodes
Electrodos
Electrodes
Elettrodi



Ø 4 mm

Kugelelektrode
ball electrode

XR 845/50



Messerelektrode, abgewinkelt
knife electrode, angled

XR 845/52



Messerelektrode, 25 mm x 3,2 mm
knife electrode, 25 mm x 3.2 mm

XR 845/54



Nadelelektrode, 12 mm x 0,5 mm
needle electrode, 12 mm x 0.5 mm

XR 845/56



Nadelelektrode, 12 mm x 0,7 mm
needle electrode, 12 mm x 0.7 mm

XR 845/58

Arthroskopieelektroden
 Arthroscopic electrodes
 Electrodo de artroscopia
 Électrodes d'arthroscopie
 Elettrodi per artroscopia

arthroscopy

monopolar



Monopolare Arthroskopieelektroden, mit Handgriff, 5x wiederverwendbar
monopolar arthroscopic electrodes, with handle, 5x reusable



Hakenelektrode, Spitze Ø 0,6 mm, 1,5 mm, 90° abgewinkelt
 hook electrode, tip Ø 0.6 mm, 1.5 mm, 90° angled

XR 848/01



Hakenelektrode, Spitze Ø 0,6 mm, 4 mm, 90° abgewinkelt
 hook electrode, tip Ø 0.6 mm, 4 mm, 90° angled

XR 848/02



Nadelelektrode, Spitze Ø 0,6 mm, 2 mm, 45° abgewinkelt
 needle electrode, tip Ø 0.6 mm, 2 mm, 45° angled

XR 848/03



Messerelektrode, Spitze Ø 1,5 mm, 4 mm, 45° abgewinkelt
 knife electrode, tip Ø 1.5 mm, 4 mm, 45° angled

XR 848/04



Hakenelektrode, Spitze Ø 1,5 mm, 4 mm, 90° abgewinkelt
 hook electrode, tip Ø 1.5 mm, 4 mm, 90° angled

XR 848/05



HF-Kabel für monopolare Arthroskopieelektroden
HF cable for monopolar arthroscopic electrodes

L = 3 m

L = 5 m



Martin, Berchtold, Integra

–

XR 827/05



Erbe ACC/ICC/VIO

XR 831/03

XR 831/05



Erbe T-Serie

XR 837/03

XR 837/05



Valleylab

XR 838/13

XR 838/15

Arthroskopieelektroden
 Arthroscopic electrodes
 Electrodo de artroscopia
 Électrodes d'arthroscopie
 Elettrodi per artroscopia





arthroscopy

bipolar



Bipolare Arthroskopieelektroden, mit Handgriff, 5x wiederverwendbar
bipolar arthroscopic electrodes, with handle, 5x reusable

L = 115 mm L = 170 mm

| | | | |
|--|--|------------------|------------------|
|  | Vaporisationselektrode 90° vaporisation electrode 90° | XR 849/01 | XR 849/11 |
|  | Vaporisationselektrode, 70° abgewinkelt vaporisation electrode, 70° angled | XR 849/02 | XR 849/12 |
|  | Hakenelektrode, feine Spitze, 90° abgewinkelt hook electrode, fine tip, 90° angled | XR 849/03 | – |
|  | Hakenelektrode, verstärkte Spitze, 90° abgewinkelt hook electrode, reinforced tip, 90° angled | – | XR 849/14 |



HF-Kabel für bipolare Arthroskopieelektroden
HF cable for bipolar arthroscopic electrodes

L = 3 m L = 5 m

| | | | |
|---|----------------------------|------------------|------------------|
|  | Valleylab | XR 839/01 | XR 839/11 |
|  | Martin, Berchtold, Integra | XR 839/02 | XR 839/12 |
|  | Erbe ACC/ICC/MIO | XR 839/03 | XR 839/13 |

Elektroden
Electrodes
Electrodos
Electrodes
Elettrodi

gynecology



Drahtschlingenelektrode
wire loop electrode



L = 120 mm



L = 110 mm

| | | | |
|--|---------------|------------------|------------------|
| | 20 mm x 25 mm | XR 850/00 | XR 850/50 |
| | 20 mm x 20 mm | XR 850/01 | XR 850/51 |
| | 20 mm x 15 mm | XR 850/02 | XR 850/52 |
| | 15 mm x 15 mm | XR 850/04 | XR 850/54 |
| | 10 mm x 10 mm | XR 850/03 | XR 850/53 |

Elektroden
Electrodes
Electrodos
Electrodes
Elettrodi

gynecology



| Konisationselektrode conisation electrode | L1 | L2 |  L = 115 mm |  L = 105 mm |
|---|-------|-------|--|--|
|  | 25 mm | 10 mm | XR 852/00 | XR 852/50 |
|  | 25 mm | 15 mm | XR 852/01 | XR 852/51 |
|  | 25 mm | 20 mm | XR 852/02 | XR 852/52 |

Elektroden
Electrodes
Electrodos
Electrodes
Elettrodi

plastic surgery



Nadelelektrode, biegsam, Wolfram, 0,3 mm
needle electrode, flexible, tungsten, 0.3 mm

XR 854/50



Drahtschlingenelektrode, Dreieck, biegsam, Wolfram, 7 mm, 0,2 mm
wire loop electrode, triangular, flexible, tungsten, 7 mm, 0.2 mm

XR 854/51



Drahtschlingenelektrode, Dreieck, biegsam, Wolfram, 9 mm, 0,2 mm
wire loop electrode, triangular, flexible, tungsten, 9 mm, 0.2 mm

XR 854/52



Drahtschlingenelektrode, Rhombus, biegsam, Wolfram, 10 x 6 mm
wire loop electrode, rhombus shape, flexible, tungsten, 10 x 6 mm

XR 854/53



Ø 5 mm

Drahtschlingenelektrode, biegsam, Wolfram
wire loop electrode, flexible, tungsten

XR 854/54



Ø 8 mm

Drahtschlingenelektrode, biegsam, Wolfram
wire loop electrode, flexible, tungsten

XR 854/55



Ø 1 mm

Kugelelektrode
ball point electrode

XR 854/56



Ø 3 mm

Kugelelektrode, biegsam
ball point electrode, flexible

XR 854/57



Spatelelektrode, biegsam, Wolfram, 2 mm x 6 mm
spatula electrode, flexible, tungsten, 2 mm x 6 mm

XR 854/60

Elektroden
Electrodes
Electrodos
Electrodes
Elettrodi

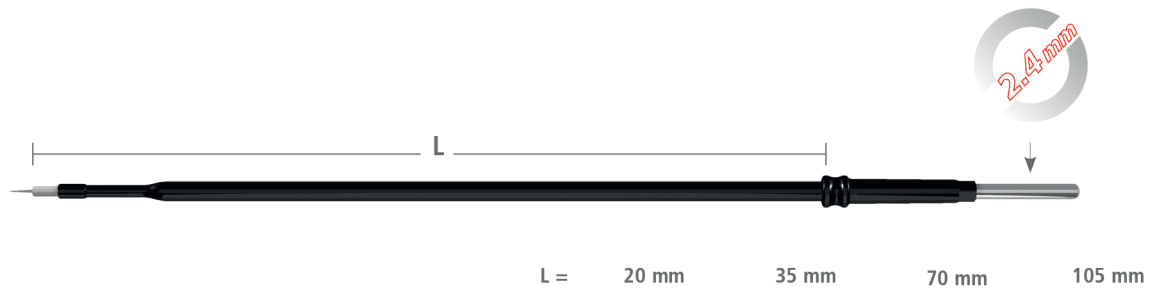

Wolframnadelektrode, mit Keramikisolation, 5 mm, 0,5 mm
tungsten needle electrode, with ceramic isolation, 5 mm, 0.5 mm

XR 855/50 XR 855/52 XR 855/54 XR 855/56



Wolframnadelektrode, mit Keramikisolation, abgewinkelt, 5 mm, 0,5 mm
tungsten needle electrode, with ceramic isolation, angled, 5 mm, 0.5 mm

XR 855/51 XR 855/53 XR 855/55 XR 855/57

dental & cosmetics



Ø 5 mm

Drahtschlingenelektrode
wire loop electrode

XR 856/60



Ø 1,7 mm

Kugelelektrode, abgewinkelt
ball electrode, angled

XR 856/61



Ø 3 mm

Kugelelektrode, abgewinkelt
ball electrode, angled

XR 856/62

Elektroden
Electrodes
Electrodos
Electrodes
Elettrodi

nopa® Mikrodissektionsnadelelektroden gibt es in vielen verschiedenen Ausführungen für eine Vielzahl von chirurgischen Eingriffen. Die feine Wolframspitze ist ideal für Eingriffe, die eine präzise Gewebedissektion erfordern. Durch die minimale Größe kann mit einer niedrigeren Leistung gearbeitet werden und so das Risiko von Hitzeschäden im Gewebe minimiert werden. Das Anhaften von Gewebe wird durch die Wolframspitze minimiert und dadurch das Risiko unerwünschter Blutungen gesenkt.

nopa® microdissection needle electrodes are available in a wide range of different designs for a variety of surgical procedures. The fine tungsten tip is ideal for procedures requiring precise tissue dissection. The minimal size allows the surgeon to work at a lower power, minimizing the risk of heat damage to tissue. Tissue adhesion is minimized by the tungsten tip, reducing the risk of unwanted bleeding.



L

Ø



Mikrodissektions-Nadelelektrode, Wolfram
microdissection needle electrode, tungsten

5 mm

0,4 mm

XR 857/50



Mikrodissektions-Nadelelektrode, Wolfram
microdissection needle electrode, tungsten

20 mm

0,5 mm

XR 857/51



Mikrodissektions-Nadelelektrode, Wolfram, abgewinkelt
microdissection needle electrode, tungsten, angled

20 mm

0,5 mm

XR 857/52



Mikrodissektions-Nadelelektrode, Wolfram
microdissection needle electrode, tungsten

40 mm

0,4 mm

XR 857/53



Mikrodissektions-Nadelelektrode, Wolfram, abgewinkelt
microdissection needle electrode, tungsten, angled

40 mm

0,4 mm

XR 857/54

Elektroden, Verlängerungen
 Electrodes, extensions
 Electrodo, extensiones
 Electrodes, extensions
 Elettrodi, estensioni



L = 75 mm

L = 110 mm



Mikrodissektions-Nadelelektrode, Wolfram, Ø 0,4 mm
 microdissection needle electrode, tungsten, Ø 0.4 mm

XR 858/50

XR 858/52



Mikrodissektions-Nadelelektrode, Wolfram, abgewinkelt, Ø 0,4 mm
 microdissection needle electrode, tungsten, angled, Ø 0.4 mm

XR 858/51

XR 858/53

Verlängerungen
extensions



Elektrodenverlängerung
 extension for electrodes

L



L



80 mm

XR 859/01

70 mm

XR 859/51

100 mm

XR 859/02

90 mm

XR 859/52

150 mm

XR 859/03

140 mm

XR 859/53

200 mm

XR 859/04

150 mm

XR 859/54



KOAGULATIONSPINZETTEN
COAGULATION FORCEPS
PINZAS DE COAGULACIÓN
PINCES DE COAGULATION
PINZE COAGULAZIONE

XR

monopolar
monopolar

28-29

bipolar
bipolar

30-33

bipolar - antihft
bipolar - non-stick

34-36



Pinzetten monopolar
 Forceps monopolar
 Pinzas monopolares
 Pinces monopolaires
 Pinze monopolari

monopolar



| | | | |
|--------|------------------|------------------|------------------|
| 145 mm | – | – | XR 882/15 |
| 160 mm | – | – | XR 882/16 |
| 180 mm | XR 880/18 | XR 881/18 | – |
| 200 mm | – | – | XR 882/20 |
| 210 mm | XR 880/21 | XR 881/21 | – |
| 250 mm | XR 880/25 | XR 881/25 | – |

Pinzetten monopolar
 Forceps monopolar
 Pinzas monopolares
 Pincas monopolaires
 Pinze monopolari

monopolar



mit Stecker
 with plug
 con clavija
 avec fiche
 con connettore



mit Buchse
 with jack
 con enchufe
 avec douille
 con presa

| | | | | | | |
|--------|------------------|------------------|------------------|------------------|------------------|------------------|
| 145 mm | – | – | XR 885/15 | – | – | XR 888/15 |
| 160 mm | – | – | XR 885/16 | – | – | XR 888/16 |
| 180 mm | XR 883/18 | XR 884/18 | – | XR 886/18 | XR 887/18 | – |
| 200 mm | – | – | XR 885/20 | – | – | XR 888/20 |
| 210 mm | XR 883/21 | XR 884/21 | – | XR 886/21 | XR 887/21 | – |
| 250 mm | XR 883/25 | XR 884/25 | – | XR 886/25 | XR 887/25 | – |

Bi-Koagulationspinzetten
 Bi-coagulation forceps
 Pinzas para la bi-coagulación
 Pinces bipolaires
 Pinze per la bi-coagulazione

bipolar

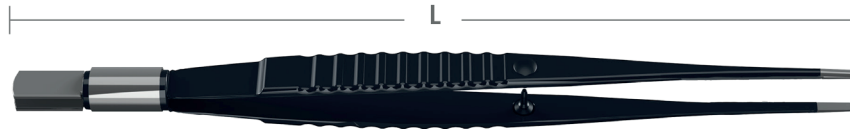

| L | Nadel / needle | 0,5 mm | 1,0 mm | 2,0 mm |
|--------|-------------------|-------------------|-------------------|-------------------|
| 145 mm | – | – | XR 890/14C | – |
| 165 mm | XR 890/16E | XR 890/16D | XR 890/16C | XR 890/16A |
| 180 mm | XR 890/18E | XR 890/18D | XR 890/18C | XR 890/18A |
| 195 mm | XR 890/20E | XR 890/20D | XR 890/20C | XR 890/20A |
| 225 mm | XR 890/22E | XR 890/22D | XR 890/22C | XR 890/22A |
| 260 mm | – | – | – | XR 890/26A |

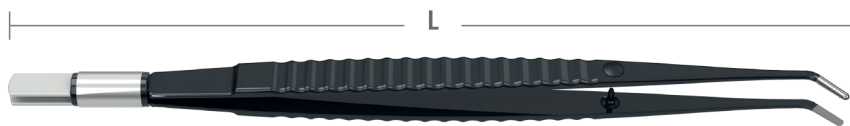

| L | Nadel / needle | 0,5 mm | 1,0 mm | 2,0 mm |
|--------|-------------------|-------------------|-------------------|-------------------|
| 145 mm | – | – | XR 891/14C | – |
| 165 mm | XR 891/16E | XR 891/16D | XR 891/16C | – |
| 180 mm | XR 891/18E | XR 891/18D | XR 891/18C | XR 891/18A |
| 195 mm | XR 891/20E | XR 891/20D | XR 891/20C | XR 891/20A |
| 225 mm | XR 891/22E | XR 891/22D | XR 891/22C | XR 891/22A |

Bi-Koagulationspinzetten
Bi-coagulation forceps
Pinzas para la bi-coagulación
Pincas bipolaires
Pinze per la bi-coagulazione

bipolar

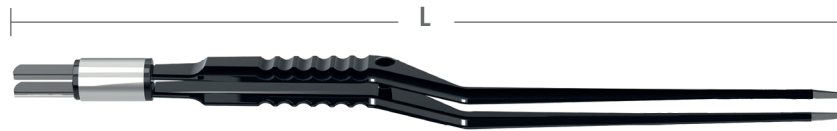

| L | Nadel / needle | 0,5 mm | 1,0 mm | 2,0 mm |
|--------|-------------------|-------------------|-------------------|-------------------|
| 165 mm | XR 894/16E | XR 894/16D | XR 894/16C | — |
| 180 mm | XR 894/18E | XR 894/18D | XR 894/18C | XR 894/18A |
| 195 mm | XR 894/20E | XR 894/20D | XR 894/20C | XR 894/20A |
| 220 mm | XR 894/22E | XR 894/22D | XR 894/22C | XR 894/22A |
| 240 mm | — | XR 894/24D | XR 894/24C | XR 894/24A |



| L | 1,0 mm |
|--------|-------------------|
| 195 mm | XR 895/20C |
| 220 mm | XR 895/22C |
| 240 mm | XR 895/24C |



| L | 1,0 mm |
|--------|-------------------|
| 195 mm | XR 896/20C |
| 220 mm | XR 896/22C |
| 240 mm | XR 896/24C |

Bi-Koagulationspinzetten
 Bi-coagulation forceps
 Pinzas para la bi-coagulación
 Pinces bipolaires
 Pinze per la bi-coagulazione

bipolar

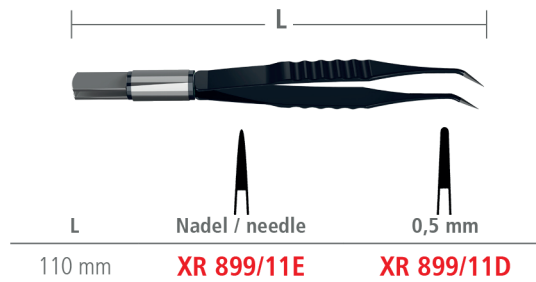
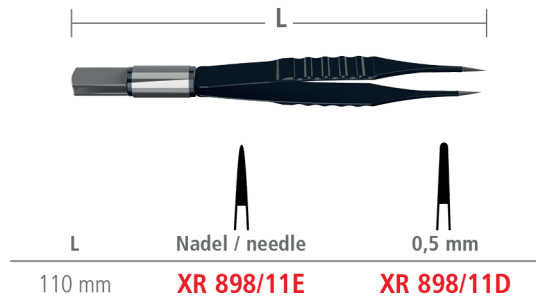

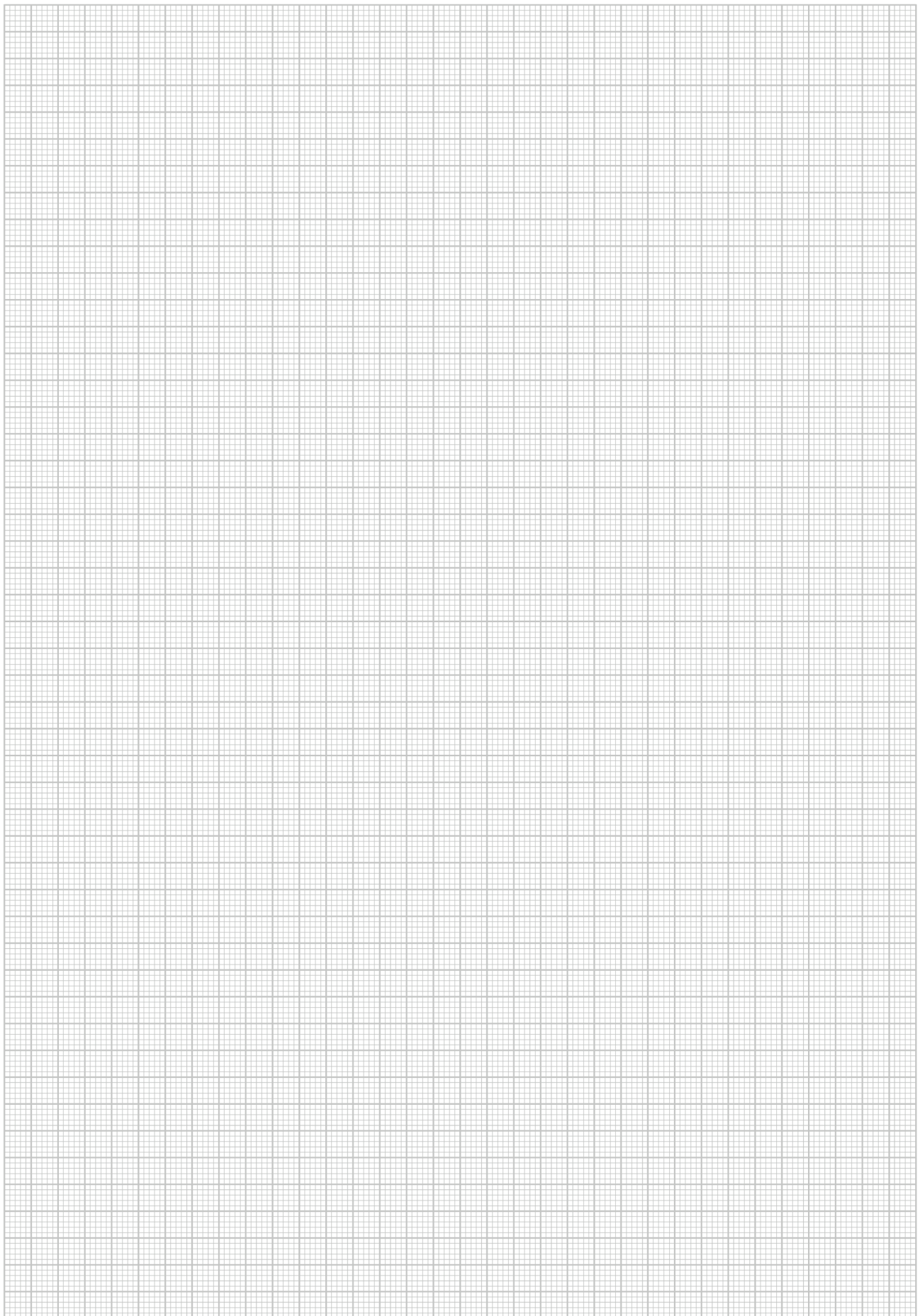

Bi-Koagulationspinzetten
 Bi-coagulation forceps
 Pinzas para la bi-coagulación
 Pinces bipolaires
 Pinze per la bi-coagulazione

nopa[®] Bi-Koagulationspinzetten zeichnen sich durch ihre einzigartige Antihafteigenschaft aus. Diese wird durch eine Vollsilberlegierung der Spitze erreicht. Die Pinzetten sind in gerader, gewinkelter und bajonettförmiger Ausführung erhältlich.

nopa[®] bi coagulation forceps are characterized by their unique anti-stick property. This is achieved by a full silver alloy of the tip. The forceps are available in straight, angled and bayonet shape.

non-stick Vollsilberlegierung, für beste Antihafteigenschaften
 solid all-silver alloy, for best non-stick effects

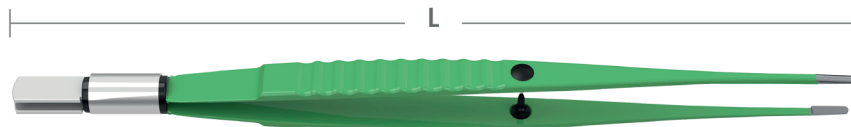

| L | Nadel / needle | 0,5 mm | 1,0 mm | 2,0 mm |
|--------|-------------------|-------------------|-------------------|-------------------|
| 145 mm | – | – | XR 900/14C | – |
| 165 mm | XR 900/16E | XR 900/16D | XR 900/16C | XR 900/16A |
| 180 mm | XR 900/18E | XR 900/18D | XR 900/18C | XR 900/18A |
| 195 mm | XR 900/20E | XR 900/20D | XR 900/20C | XR 900/20A |
| 225 mm | XR 900/22E | XR 900/22D | XR 900/22C | XR 900/22A |
| 260 mm | – | – | – | XR 900/26A |

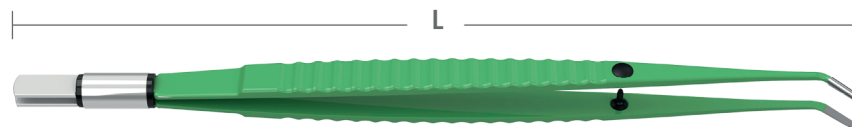

| L | Nadel / needle | 0,5 mm | 1,0 mm | 2,0 mm |
|--------|-------------------|-------------------|-------------------|-------------------|
| 145 mm | – | – | – | – |
| 165 mm | XR 901/16E | XR 901/16D | XR 901/16C | – |
| 180 mm | XR 901/18E | XR 901/18D | XR 901/18C | XR 901/18A |
| 195 mm | XR 901/20E | XR 901/20D | XR 901/20C | XR 901/20A |
| 225 mm | XR 901/22E | XR 901/22D | XR 901/22C | XR 901/22A |

Bi-Koagulationspinzetten
 Bi-coagulation forceps
 Pinzas para la bi-coagulación
 Pinces bipolaires
 Pinze per la bi-coagulazione

bipolar
non-stick

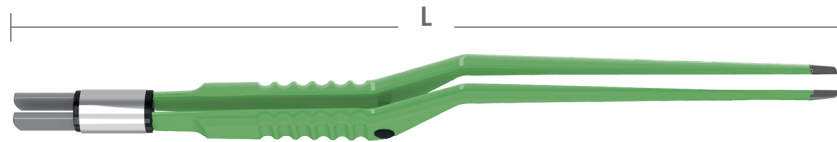

| L | Nadel / needle | 0,5 mm | 1,0 mm | 2,0 mm |
|--------|-------------------|-------------------|-------------------|-------------------|
| 165 mm | XR 904/16E | XR 904/16D | XR 904/16C | — |
| 180 mm | XR 904/18E | XR 904/18D | XR 904/18C | XR 904/18A |
| 195 mm | XR 904/20E | XR 904/20D | XR 904/20C | XR 904/20A |
| 220 mm | XR 904/22E | XR 904/22D | XR 904/22C | XR 904/22A |
| 240 mm | — | XR 904/24D | XR 904/24C | XR 904/24A |

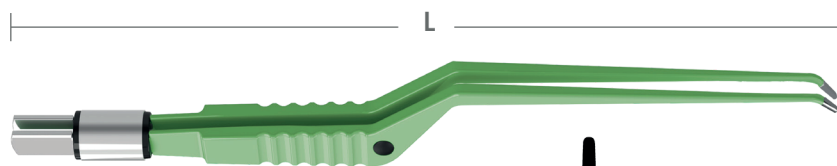

| L | 1,0 mm |
|--------|-------------------|
| 195 mm | XR 905/20C |
| 220 mm | XR 905/22C |

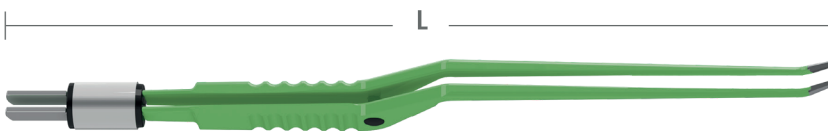

| L | 1,0 mm |
|--------|-------------------|
| 195 mm | XR 906/20C |
| 220 mm | XR 906/22C |
| 240 mm | XR 906/24C |

Bi-Koagulationspinzetten
 Bi-coagulation forceps
 Pinzas para la bi-coagulación
 Pinces bipolaires
 Pinze per la bi-coagulazione

bipolar
non-stick

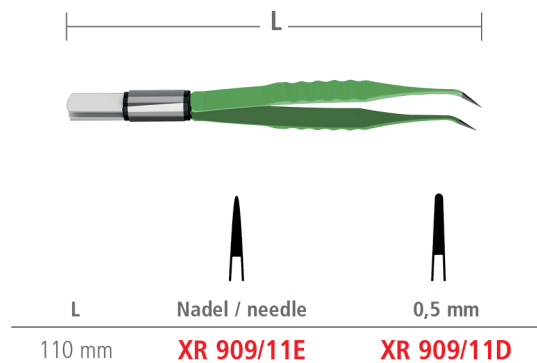
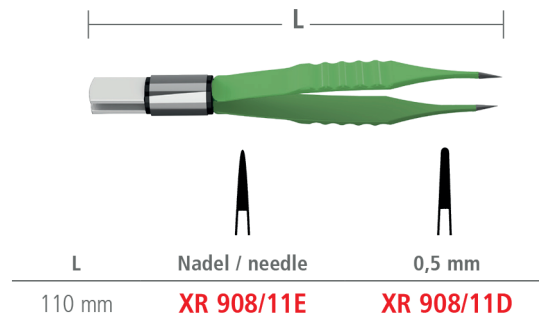

ANSCHLUSSKABEL & ZUBEHÖR
CONNECTION CORDS & ACCESSORIES
CABLES DE CONEXIÓN & ACCESORIOS
CÂBLES DE RACCORDEMENT & ACCESSOIRES
CAVI DA CONNESSIONE & ACCESSORI

XR

| | |
|---|-------|
| monopolar monopolar | 38 |
| bipolar bipolar | 39-40 |
| Neutralelektroden neutral electrodes | 41 |



Anschlusskabel
 Connection cords
 Cables de conexión
 Câbles de raccordement
 Cavi da connessione





monopolar



Länge
length

Buchse, 4 mm
socket, 4 mm

Resektoskop, 2 mm
resectoscope, 2 mm





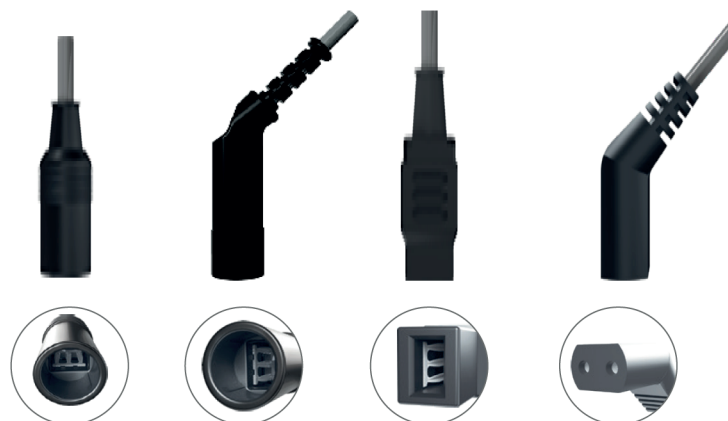

| | Länge length | Buchse, 4 mm socket, 4 mm | Resektoskop, 2 mm resectoscope, 2 mm |
|---|-----------------|------------------------------|---|
| Erbe Vio/ICC/ACC  | 3 m | XR 831/03 | XR 824/13 |
| | 5 m | XR 831/05 | XR 824/15 |
| Martin, Berchtold, Integra  | 3 m | — | — |
| | 5 m | XR 827/05 | XR 824/05 |
| Erbe T-Serie  | 3 m | XR 837/03 | XR 837/13 |
| | 5 m | XR 837/05 | XR 837/17 |
| Valleylab  | 3 m | XR 838/13 | XR 824/23 |
| | 5 m | XR 838/15 | XR 824/25 |
| Ellman  | 3 m | XR 838/33 | — |
| | 5 m | — | — |

Anschlusskabel
 Connection cords
 Cables de conexión
 Câbles de raccordement
 Cavi da connessione

bipolar

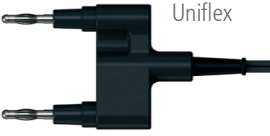

Länge length
 Flachstecker, gerade flat plug, straight
 Flachstecker, gewinkelt flat plug, angled
 Flachstecker, Vierkant flat plug, square
 2-Pin-Stecker, gewinkelt 2-pin-plug, angled

| | | | | | |
|---|-----|------------------|------------------|------------------|------------------|
|  Erbe Vio/ICC/ACC, Storz | 3 m | XR 839/03 | – | XR 832/03 | XR 833/13 |
| | 5 m | XR 839/13 | XR 839/55 | XR 832/05 | XR 833/15 |
|  Martin, Berchtold, Integra | 3 m | XR 839/02 | – | XR 830/03 | XR 833/23 |
| | 5 m | XR 839/12 | XR 839/65 | XR 830/05 | XR 833/25 |
|  Valleylab | 3 m | XR 839/01 | – | XR 829/13 | XR 833/33 |
| | 5 m | XR 839/11 | XR 839/75 | XR 829/15 | XR 833/35 |
|  Ellman | 3 m | XR 839/23 | – | – | XR 833/43 |
| | 5 m | – | – | – | – |
|  Uniflex | 3 m | XR 839/33 | – | – | – |
| | 5 m | XR 839/35 | – | – | – |
|  US-Modelle 2-Pol* | 3 m | XR 839/43 | – | XR 834/03 | XR 833/63 |
| | 5 m | XR 839/45 | XR 839/95 | XR 834/05 | XR 833/65 |

*entspricht nicht EU-Bestimmungen
 *not in compliance with EU standards

Anschlusskabel
 Connection cords
 Cables de conexión
 Câbles de raccordement
 Cavi da connessione







bipolar



Länge
length

Stecker Wolf,
bipolare Zange
plug Wolf,
bipolar clamp

bipolares
Resektoskop
bipolar
resectoscope

| | | | |
|---|-----|------------------|------------------|
| Erbe Vio/ICC/ACC, Storz | 3 m | XR 831/12 | — |
|  | 5 m | XR 831/13 | — |
| Martin, Berchtold, Integra | 3 m | — | XR 824/43 |
|  | 5 m | XR 830/13 | XR 824/45 |
| Valleylab | 3 m | XR 831/16 | XR 824/53 |
|  | 5 m | — | XR 824/55 |
| Ellman | 3 m | — | — |
|  | 5 m | — | — |
| Uniflex | 3 m | — | — |
|  | 5 m | — | — |
| US-Modelle 2-Pol* | 3 m | XR 831/22 | XR 824/33 |
|  | 5 m | — | XR 824/35 |

*entspricht nicht EU-Bestimmungen
 *not in compliance with EU standards

Neutralelektroden, Anschlusskabel
 Neutral electrodes, connection cords
 Electrodo neutros, cables de conexión
 Électrodes neutres, câbles de raccordement
 Elettrodi neutri, cavi da connessione



Länge
length

Neutralelektrodenstecker
neutral electrode plug

Neutralelektrodenstecker
neutral electrode plug



Erbe, Martin Ø 6,3 mm

3 m

–

XR 835/35

5 m

–

XR 835/55



Erbe ACC/ICC, Martin

3 m

XR 836/31

–

5 m

XR 836/51

–



Valleylab

3 m

–

XR 835/63

5 m

–

XR 835/65

↑
passend für
suitable for
↑



Neutralelektrode
neutral electrode

260 x 150 mm

XR 836/91

XR 835/91

160 x 80 mm

XR 836/92

XR 835/92



sim

1900

nce

02





nopa[®] instruments
traditionally modern

nopa instruments

Medizintechnik GmbH
Weilatten 7-9
78532 Tuttlingen/Germany

Tel. +49 7462 9490-0
Fax +49 7462 9490-90
info@nopa.de
www.nopa.de

Herstellung und Verkauf chirurgischer
und endoskopischer Instrumente.
Manufacture and Sales of Surgical
and Endoscopic Instruments.

