

---

endoskopie

endoscopy

endoscopia

endoscopie

endoscopia

nopa<sup>®</sup> instruments



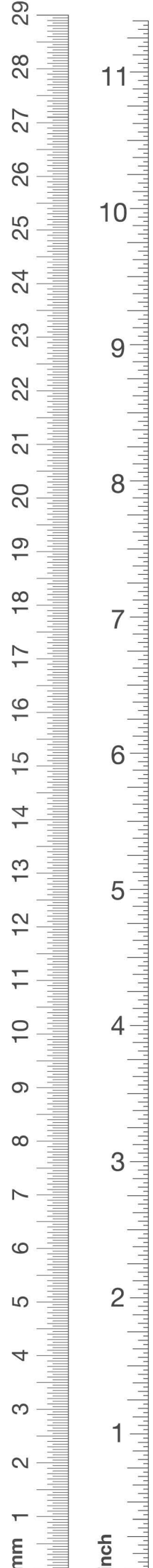

Dies ist unser Katalog, er bleibt unser ausschließliches Eigentum. Es gelten unsere allgemeinen Lieferbedingungen. Sie finden diese auf unserer Internetseite: [www.nopa-instruments.com](http://www.nopa-instruments.com).

This is our Catalogue. It remains our exclusive property. Please find our "General Terms of Sale" on our corporate website: [www.nopa-instruments.com](http://www.nopa-instruments.com).

Esto es nuestro catálogo queda nuestra propiedad. Nuestros condiciones generales de venta se encuentran en nuestra página web: [www.nopa-instruments.com](http://www.nopa-instruments.com).

Voilà notre catalogue et il demeure notre propriété. Veuillez consulter nos conditions générales de vente sur notre page Internet: [www.nopa-instruments.com](http://www.nopa-instruments.com).

Questo è nostro catalogo e rimane nostra proprietà. Trovano applicazione le nostre condizioni generali di fornitura, che sono disponibili sul nostro sito: [www.nopa-instruments.com](http://www.nopa-instruments.com).

Modelländerungen vorbehalten. Nachdruck, auch auszugsweise, verboten.  
Change of design and pattern reserved. Re-printing, even in extracts, not permitted.  
Nos reservamos el derecho de modificaciones sin aviso previo. Reimpresión, también parcialmente, está prohibido.  
Tous droits réservés aux changements de modèle. Réimprimer, également partiellement, est interdit.  
Noi riserviamo il diritto di effettuare delle modificazioni. Ristampa di divieto anche parziale.



Bitte fordern Sie unsere  
entsprechenden Kataloge an.

---

Please request for our  
appropriate catalogues.

---

Por favor pida por nuestros  
catálogos apropiados.

---

Veillez demander nos  
catalogues appropriés.

---

Chieda prego i nostri  
cataloghi adatti.

---

**>> Unser Lieferprogramm**

Allgemeinchirurgie und Gynäkologie  
Plastische Chirurgie und HNO  
Cardiovascular  
Neurochirurgie  
Ophthalmologie  
Endoskopie  
Behältnisse zur Instrumentensterilisation  
Dental und Oral

**>> Our product range**

General Surgery and Gynecology  
Plastic Surgery and ENT  
Cardiovascular  
Neurosurgery  
Ophthalmology  
Endoscopy  
Sterilizing Containers  
Dental and Oral

**>> Nuestro gama  
de productos**

Cirugía generales y Ginecología  
Cirugía plástica y ORL  
Cardiovasculares  
Neurocirugía  
Oftalmología  
Endoscópico  
Cajas para esterilización  
Odontología y Oral

**>> Notre gamme**

Chirurgie générale et Gynecologie  
Chirurgie plastique et ORL  
Cardiovasculaires  
Neurochirurgie  
Ophtalmologie  
Endoscopie  
Des boîtes à instruments et pour la stérilisation  
Dental et Oral

**>> Nostro programma  
di produzione**

Chirurgia generale e Ginecologia  
Chirurgia plastica ed ORL  
Cardiovascolari  
Neurochirurgia  
Oftalmologia  
Endoscopia  
Astucci per la sterilizzazione  
Odontoiatria e Orale









thank you for choosing  
**nopa** instruments...

...you obviously have  
good taste





laparoscopy basic	>> Laparoskopie basic • Laparoscopy basic	61–62
thoracoscopy basic	>> Thorakoskopie basic • Thoracoscopy basic	63–64
lap/thor equipment	>> Laparoskopie / Thorakoskopie Geräte • Laparoscopy / Thoracoscopy equipment 65–66	
resectoscopy basic	>> Resektoskopie basic • Resectoscopy basic	133–134
cystoscopy basic	>> Zystoskopie basic • Cystoscopy basic	143–144
res/cyst equipment	>> Resektoskopie / Zystoskopie Geräte • Resectoscopy / Cystoscopy equipment	145–146
hysteroscopy basic	>> Hysteroskopie basic • Hysteroscopy basic	165–166
hysteroscopy equipment	>> Hysteroskopie Geräte • Hysteroscopy equipment	167–168
arthroscopy basic	>> Arthroskopie basic • Arthroscopy basic	187–188
arthroscopy equipment	>> Arthroskopie Geräte • Arthroscopy equipment	189–190
ent endoscopy basic	>> HNO-Endoskopie basic • ENT-Endoscopy basic	205–206



>> Optiken • Telescopes • Opticas • Optiques • Ottiche	7–20	<b>1</b>
>> Instrumente für Laparoskopie / Pelviskopie / Thorax • Instruments for Laparoscopy / Pelviscopy / Thorax • Instrumentos para Laparoscopia / Pelviscopia / Tórax Instruments pour Laparoscopie / Pelviscopia / Thorax • Strumenti per Laparoscopia / Pelviscopia / Torace	21–66	<b>3</b>
>> Elektroden / Saugen / Spülen / Kanülen / Trokare • Electrodes / Suction / Irrigation / Cannulae / Trocars • Electrodos / Succión / Irrigación / Aguja / Trócares • Electrodes / Aspiration / Irrigation / Canules / Trocars • Elettrodi / Aspirazione / Irrigazione / Aghi speciali / Tre quarti	67–90	<b>5</b>
>> HF-Zubehör • HF-accessories • AF-accesorios • HF-accessoires • AF-accessori	91–102	<b>7</b>
>> Flexible Instrumente • Flexible instruments • Instrumentos flexibles Instruments flexibles • Strumenti flessibili	103–114	<b>9</b>
>> Urologie und Hysteroskopie • Urology and Hysteroscopy • Urología y Histeroscopia Urologie et Hysteroscopie • Urologia e Isteroscopia	115–168	<b>12</b>
>> Arthroskopie • Arthroscopy • Artroscoopia • Arthroscopie • Artroscofia	169–190	<b>14</b>
>> Sinuskopie • Sinuscopy • Sinuscopia • Sinuscopie • Sinuscopia	191–206	<b>16</b>
>> Kaltlichtquellen, Kameras • Cold light sources, cameras • Fuentes de luz fria, cámaras Sources à lumière froide, caméras • Sorgente luce fredda, macchina fotografiche	207–226	<b>18</b>
>> Insufflatoren / Saug- und Spülgeräte • Insufflators / Suction and Irrigation Units Insufladores / Unidad de succión y irrigación • Insufflateurs / Ustensiles d'Aspiration / Irrigation • Insufflatore / Unita d'aspirazione ed irrigazione	227–234	<b>20</b>
>> Verschiedenes • Various items • Artículos diversos • Articles divers • Articoli diversi	235–256	<b>22</b>



OPTIKEN  
TELESCOPES  
OPTICAS  
OPTIQUES  
OTTICHE

1

nopa<sup>®</sup> instruments







## HANDLING CLEANING DISINFECTION STERILIZATION

All you need to know about **HANDLING, CLEANING, DISINFECTION** and **STERILIZATION** of **nopa** endoscopes.

You have purchased a high-grade quality endoscope. In order to guarantee a long-lasting functioning please regard the following rules.

**GENERAL TREATMENT**

- >> Avoid excessive mechanical force.  
Note this is a rigid, not a flexible endoscope which cannot be bent. Never drop it.
- >> Always pick up the endoscope at the body of the heavy eye piece or at the main part.
- >> In order to prevent external damage, please store the endoscope in an appropriate container.

**CLEANING**

- >> Always clean the endoscope individually, separate from other instruments.
- >> Do not touch the optical devices when dry, as this can result in scratches.
- >> Wash the endoscope in enzymic cleaning solution and rinse afterwards with clear distilled fully saltless water.
- >> Dry the endoscope with a soft cotton cloth.

**DISINFECTION**

- >> Before disinfection, the endoscope should be cleaned as described previously.
- >> Leave the endoscope in a disinfecting solution for example Cidex, a maximum of 30 minutes. Always regard the instructions of the manufacturers of the disinfective solution.

**STERILIZATION**

- >> Gas (ETO)
- >> Clean according to the instructions.  
Sterilize in gas sterilizing unit according to the instructions.
- >> Steam Sterilization of autoclavable optical devices.  
Clean according to the instructions.  
Autoclave at the following parameters:  
Pressure maximal 2 bar  
max. 5 minutes 134° C  
max. 20 minutes 121° C  
The instructions of the manufacturer of the sterilizing unit have to be regarded.  
The endoscope cools automatically - additional cooling is not recommended.
- >> Hot Air Sterilization  
Not suitable and not recommended.

**GUARANTEE**

- >> **nopa instruments** guarantees full functioning of our endoscope for the period of 6 months. We will replace or repair **nopa** endoscopes free of charge, if material damage or a manufacturing defect is evident. This warranty does not cover endoscope defects due to misuse or improper handling, nor does this warranty cover any repair carried out by anyone other, than the manufacturer.

**nopa instruments** >> Medizintechnik GmbH >> Weilatten 7-9 >> D - 78532 Tuttlingen >> Germany  
>> Tel. +49.7462.9490-0 >> Fax +49.7462.9490-90 >> info@nopa.de >> www.nopa.de

**1** ENDOSKOPIE ENDOSCOPY ENDOSCOPIA ENDOSCOPIE ENDOSCOPIA

Arthroskopie und Sinuskopie  
 Arthroscopy and Sinuscopy  
 Artroscofia y Sinuscopia  
 Arthroscopie et Sinuscopie  
 Artroscofia e Sinuscopia



>> autoklavierbar  
autoclavable

>> mit Anschluss für  
with adaptors for

Storz  
Wolf  
ACMI

1/1

	STANDARD 90°			
Ø mm	$\alpha = 0^\circ$	$\alpha = 30^\circ$	$\alpha = 70^\circ$	
2,7	XP 700/30	XP 700/33	XP 700/37	



>> autoklavierbar  
autoclavable

>> mit Anschluss für  
with adaptors for

Storz  
Wolf  
ACMI

1/1

	Ø mm	$\alpha = 0^\circ$	$\alpha = 30^\circ$	$\alpha = 70^\circ$	
Arthroscope	4,0	XP 701/40	XP 701/43	XP 701/47	Wide angle
Sinuscope	4,0	XP 703/40	XP 703/43	XP 703/47	



>> autoklavierbar  
autoclavable

>> mit Anschluss für  
with adaptors for

Storz  
Wolf  
ACMI

1/1

	STANDARD 90°			
Ø mm	$\alpha = 0^\circ$	$\alpha = 30^\circ$	$\alpha = 70^\circ$	
2,7	XP 704/30	XP 704/33	XP 704/37	

Arthroskopie, Otoskopie  
 Arthroscopy, Otoscopy  
 Artroscofia, Otoscopia  
 Artroscofia, Otoscopia  
 Artroscofia, Otoscopia



**MINI ARTHROSCOPES**

Ø mm	L=(mm)	α = 0°	α = 15°
1,7	58	XP 705/10	XP 705/15
2,0	58	XP 706/20	XP 706/25
1,7	104	XP 707/10	XP 707/15
2,0	104	XP 708/20	XP 708/25

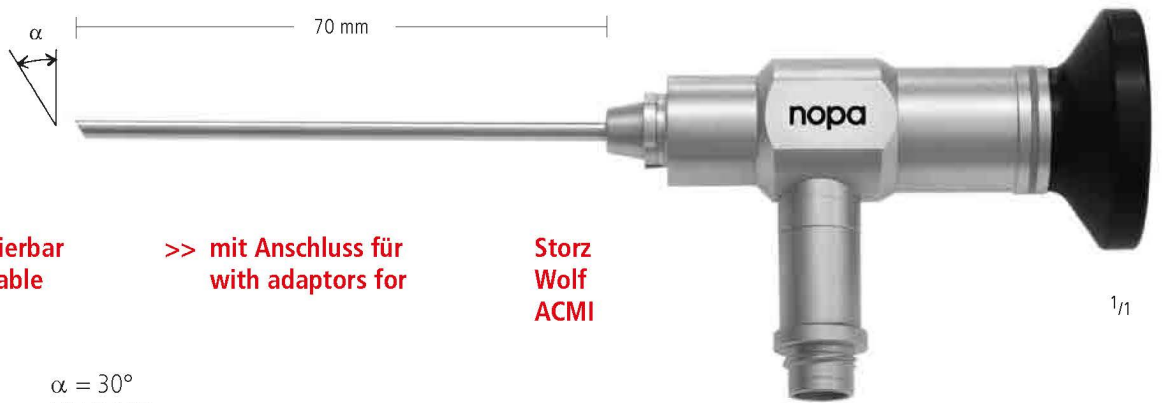

>> autoklavierbar  
 autoclavable

>> mit Anschluss für  
 with adaptors for

Storz  
 Wolf  
 ACMI

Ø mm      α = 30°  
 2,7      XP 709/30



>> autoklavierbar  
 autoclavable

>> mit Anschluss für  
 with adaptors for

Storz  
 Wolf  
 ACMI

STANDARD 90°  
 Ø mm      α = 0°      α = 30°  
 4,0      XP 718/40      XP 718/43

**1** ENDOSKOPIE ENDOSCOPY ENDOSCOPIA ENDOSCOPIE ENDOSCOPIA

Urologie und Hysteroskopie  
 Urology and Hysteroscopy  
 Urologia y Histeroscopia  
 Urologie et Hysteroscopie  
 Urologia e Isteroscopia

Kinder  
 children  
 niños  
 enfants  
 bambini

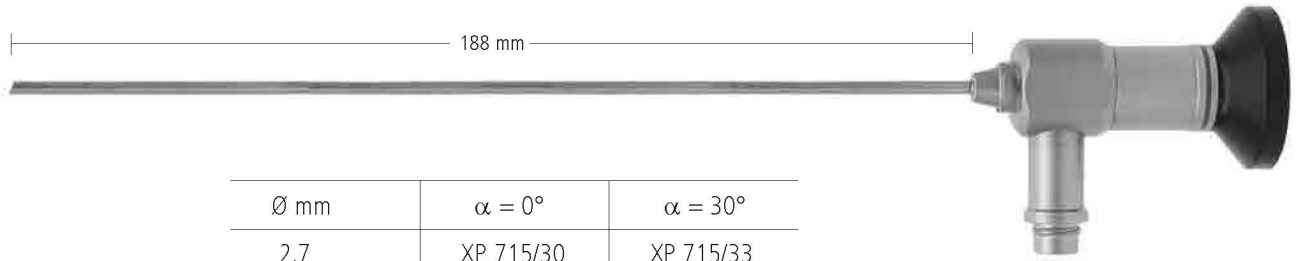

Ø mm	$\alpha = 0^\circ$	$\alpha = 30^\circ$
2,7	XP 715/30	XP 715/33

>> autoklavierbar  
 autoclavable

>> mit Anschluss für  
 with adaptors for

Storz  
 Wolf  
 ACMI

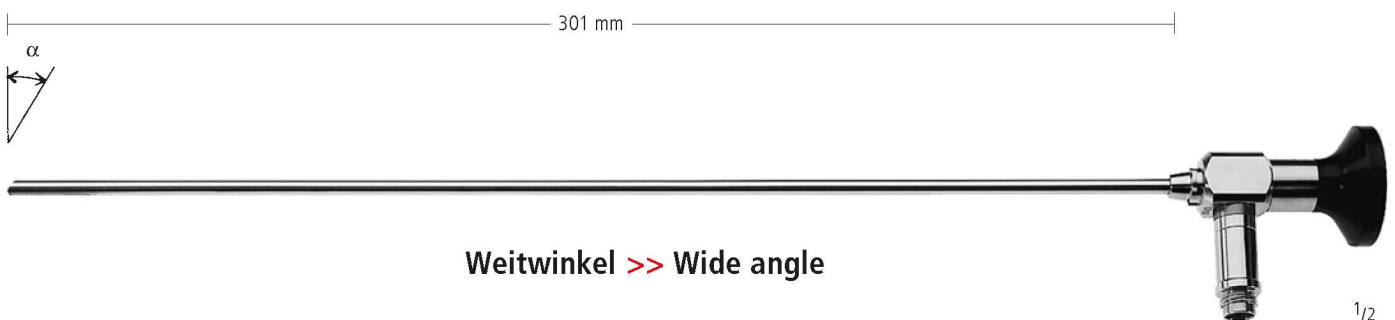

**Weitwinkel >> Wide angle**

Ø mm	$\alpha = 0^\circ$	$\alpha = 12^\circ$	$\alpha = 30^\circ$	$\alpha = 70^\circ$
2,7	XP 720/20		XP 720/23	
4,0	XP 720/40	XP 720/42	XP 720/43	XP 720/47

>> autoklavierbar  
 autoclavable

>> mit Anschluss für  
 with adaptors for

Storz  
 Wolf  
 ACMI



Laparoskopie  
Laparoscopy  
Laparoscopia  
Laparoscopie  
Laparoscopia

1

3

5

7

9

12

14

16

18

20

22

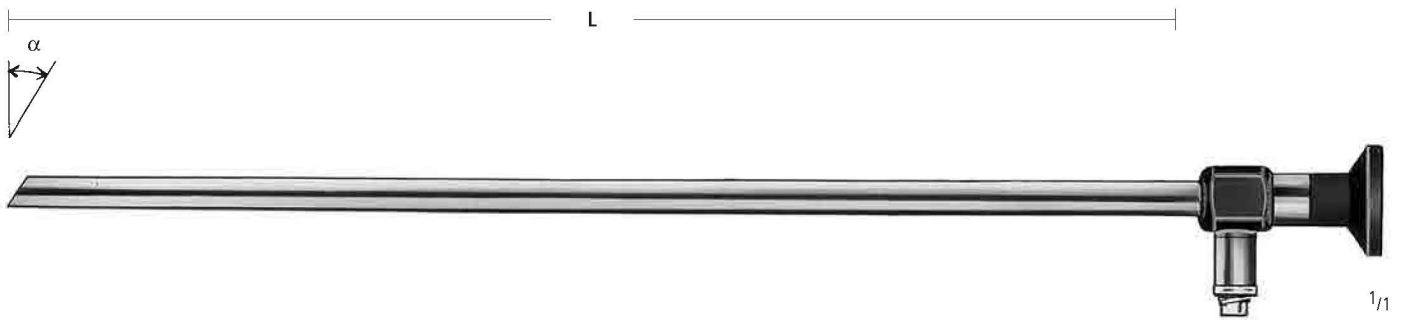

Ø mm	α = 0°	α = 30°	L
5,0	XP 720/50	XP 720/53	336 mm
6,5	XP 720/60	XP 720/63	336 mm
8,0	XP 721/80	XP 721/83	340 mm
10,0	XP 722/90	XP 722/93	344 mm

>> autoklavierbar  
autoclavable

>> mit Anschluss für  
with adaptors for

Storz  
Wolf  
ACMI

1 ENDOSKOPIE ENDOSCOPY ENDOSCOPIA ENDOSCOPIE ENDOSCOPIA

Laparoskopie  
Laparoscopy  
Laparoscopia  
Laparoscopie  
Laparoscopia



Ø mm	Ø i mm	$\alpha = 0^\circ$
10	6	XP 725/90

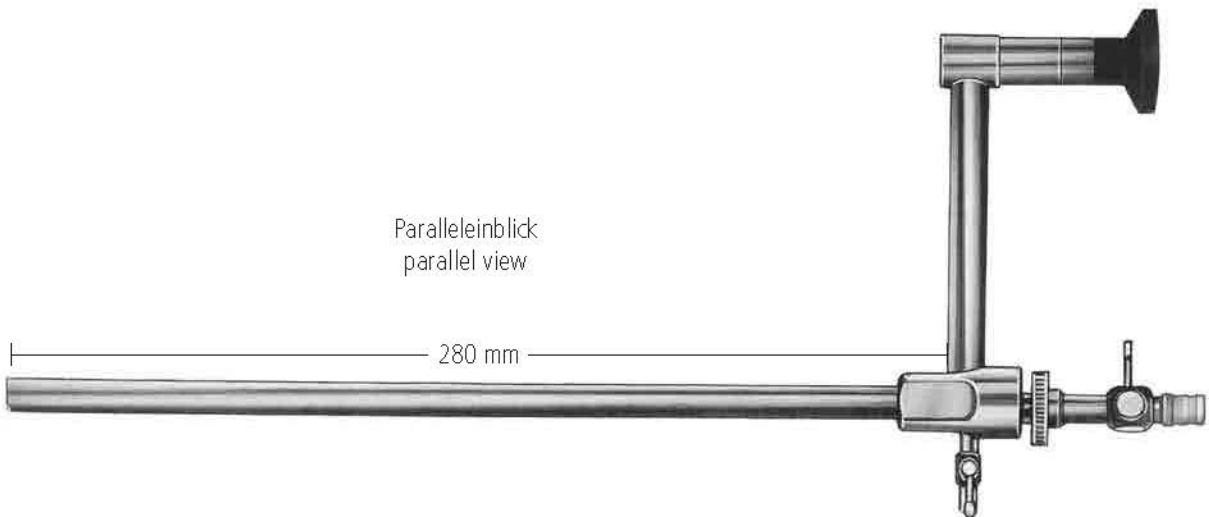

Ø mm	Ø i mm	$\alpha = 0^\circ$
10	6	XP 726/90

ENDOSKOPIE ENDOSCOPY ENDOSCOPIA ENDOSCOPIE ENDOSCOPIA

Thorakoskopie - Bronchoskopie  
 Thoracoscopy - Bronchoscopy  
 Torascoscopia - Bronquioscopia  
 Thorascoscopia - Bronchoscopy  
 Toracosopia - Broncoscopia

1

3

5

7

9

12

14

16

18

20

22

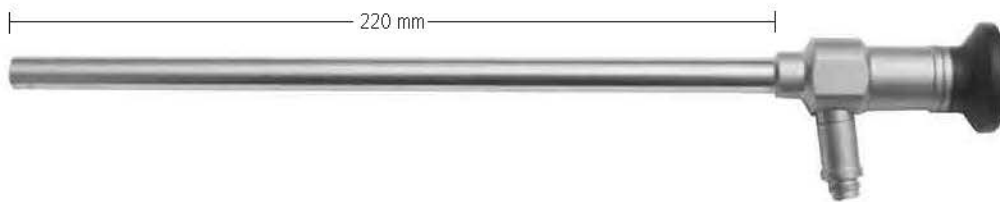

Ø mm	$\alpha = 0^\circ$	$\alpha = 30^\circ$
10,0	XP 728/10	XP 728/13

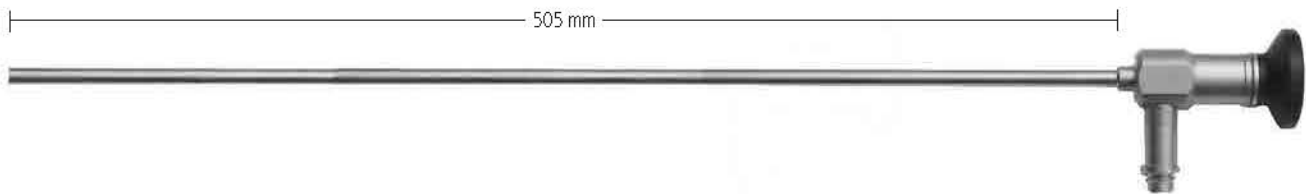

Ø mm	$\alpha = 0^\circ$	$\alpha = 30^\circ$
5,5	XP 729/50	XP 729/53

>> autoklavierbar  
autoclavable

>> mit Anschluss für  
with adaptors for

Storz  
Wolf  
ACMI

1 ENDOSKOPIE ENDOSCOPY ENDOSCOPIA ENDOSCOPIE ENDOSCOPIA

Uretero Renoskop / Nephroskop  
 Uretero renoscope / nephroscope  
 Uretero-renoscopio / nefroscopio  
 Urétérórénoscope / néphroscope  
 Renoscopio / nefroscopio uretero



Uretero Renoskop halbstar  
 Uretero renoscope semiflexible

XP 740/42

komplett mit	XP 740/01 + XP 740/04
complete with	XP 740/01 + XP 740/04
completo con	XP 740/01 + XP 740/04
complet avec	XP 740/01 + XP 740/04
completo con	XP 740/01 + XP 740/04



Adapter für Lithotripsie  
 Adaptor for lithotripsy

XP 740/01



Spülhahnaufnahme  
 Stopcock input unit

XP 740/04

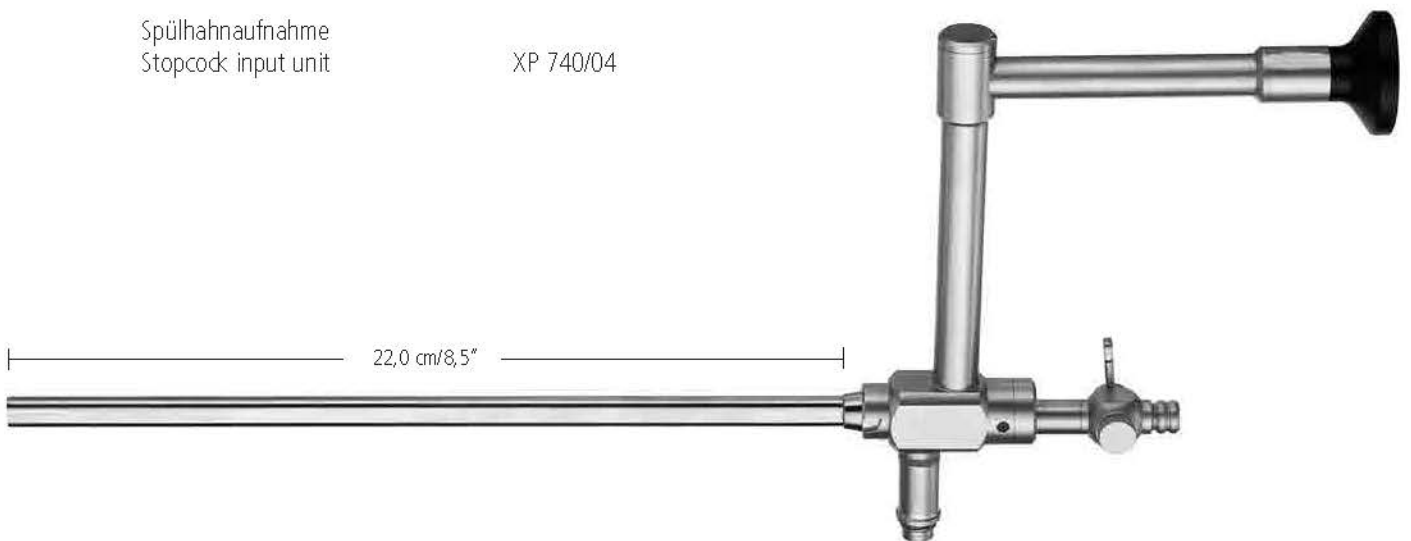

Nephroskop  
 Nephroscope

XP 745/22



Sterilisation  
Sterilization  
Esterilizacion  
Sterilisation  
Sterilizzazione

# nopa<sup>®</sup> containersystem

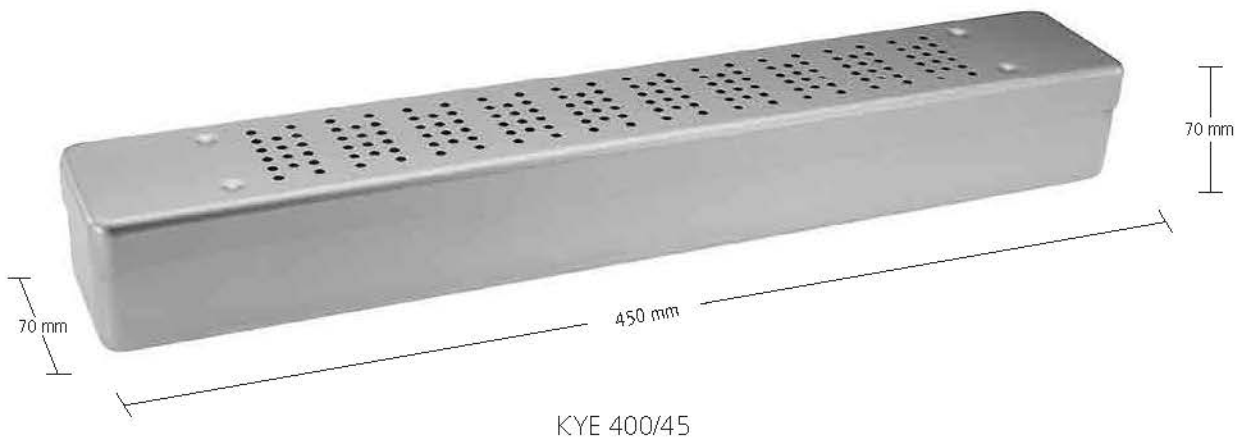
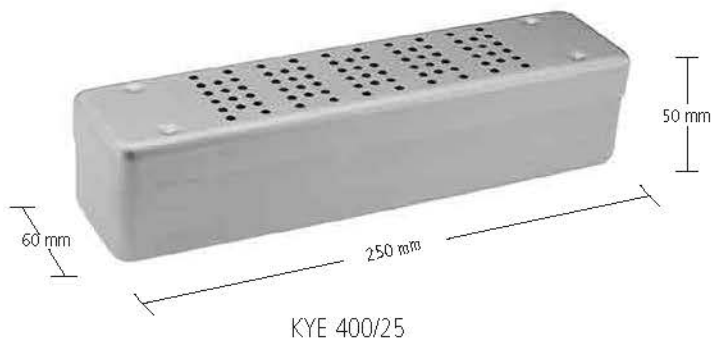

**1** ENDOSKOPIE ENDOSCOPY ENDOSCOPIA ENDOSCOPIE ENDOSCOPIA

Sterilisation  
 Sterilization  
 Esterilizacion  
 Sterilisation  
 Sterilizzazione



Nur Deckel farbig  
 Lid colored only  
 Solamente tapas en diferentes colores  
 Couverture de couleur seulement  
 Solo coperchio colorato

L(mm)	B(mm)	H(mm)			
250	60	50	KYE 400/35	KYE 400/36	KYE 400/37
450	70	70	KYE 400/55	KYE 400/56	KYE 400/57

Sterilisation  
Sterilization  
Esterilizacion  
Sterilisation  
Sterilizzazione

1  
3  
5  
7  
9  
12  
14  
16  
18  
20  
22



L(mm)	B(mm)	H(mm)	
290	80	52	KYE 401/29
460	80	52	KYE 401/46
640	150	77	KYE 401/64
670	80	52	KYE 401/67



Mit Silikonfixierungen  
with silicon fixation



INSTRUMENTE FÜR LAPAROSKOPIE /  
PELVISKOPIE / THORAX

INSTRUMENTS FOR LAPAROSCOPY /  
PELVISCOPY / THORAX

INSTRUMENTOS PARA LAPAROSCOPIA /  
PELVISCOPIA / TORAX

INSTRUMENTS POUR LAPAROSCOPIE /  
PELVISCOPE / THORAX

STRUMENTI PER LAPAROSCOPIA /  
PELVISCOPIA / TORACE

3

easyClean®

nopa® instruments







Kinder  
Children  
Niños  
Enfants  
Bambini

# easyClean®

Ø 3,0 mm, 2-teilig / 2-piece



1

3

5

7

9

12

14

16

18

20

22



XM 010/00



XM 014/00



XM 016/00

Bestellinformation: Bestellen Sie bitte Griff und Arbeitseinsatz  
Ordering information: Please order handle and working tip

Scharfe Präparation, Faszangen  
 Sharp Dissection, Grasping Forceps  
 Disección punta, Pinzas de aprehensión  
 Dissection tranchant, Pincas à préhension  
 Dissezione tagliente, Pinze da presa

easyClean<sup>®</sup>

Ø 3,0 mm, 2-teilig / 2-piece



20,0 cm/8"

33,0 cm/13"



Ø 3,0 mm

XM 040/20

XM 040/33

METZENBAUM



Ø 3,0 mm

XM 041/20

XM 041/33

HAKENSCHERE  
 HOOK SCISSORS



Ø 3,0 mm

XM 042/20

XM 042/33

STANZE  
 PUNCH



Ø 3,0 mm

XM 043/20

XM 043/33

METZENBAUM GERADE  
 METZENBAUM STRAIGHT



Ø 3,0 mm

XM 044/20

XM 044/33

METZENBAUM GEBOGEN GEZAHNT  
 METZENBAUM CURVED SERRATED



Ø 3,0 mm

XM 050/20

XM 050/33

GREIFZANGE  
 GRASPING FORCEPS



Ø 3,0 mm

XM 051/20

XM 051/33

KELLY ZANGE  
 KELLY FORCEPS



Ø 3,0 mm

XM 052/20

XM 052/33

MARYLAND

Bestellinformation: Bestellen Sie bitte Griff und Arbeitseinsatz  
 Ordering information: Please order handle and working tip







ENDOSKOPIE ENDOSCOPY ENDOSCOPIA ENDOSCOPIE ENDOSCOPIA

Fasszangen  
Grasping Forceps  
Pinzas de aprehensión  
Pincas à préhension  
Pinze da presa

easyClean<sup>®</sup>

Ø 3,0 mm, 2-teilig / 2-piece



	1/1	Ø 3,0 mm	20,0 cm/8" XM 053/20	33,0 cm/13" XM 053/33	1 3
ATRAUMATISCHER DISSEKTOR ATRAUMATIC DISSECTOR					5
	1/1	Ø 3,0 mm	XM 054/20	XM 054/33	7 9
GREIFZANGE GRASPING FORCEPS					12
	1/1	Ø 3,0 mm	XM 055/20	XM 055/33	14
GREIFZANGE COBRA GRASPING FORCEPS COBRA					16
	1/1	Ø 3,0 mm	XM 056/20	XM 056/33	18
FASSZANGE DELPHIN GRASPING FORCEPS DOLPHIN					20
	1/1	Ø 3,0 mm	XM 057/20	XM 057/33	22
LÖFFEL SPOON					
	1/1	Ø 3,0 mm	XM 058/20	XM 058/33	
FASSZANGE GRASPING FORCEPS					
	1/1	Ø 3,0 mm	XM 059/20	XM 059/33	
FASSZANGE GEFENSTERT GRASPING FORCEPS FENESTRATED					

Bestellinformation: Bestellen Sie bitte Griff und Arbeitseinsatz  
Ordering information: Please order handle and working tip

**3** ENDOSKOPIE ENDOSCOPY ENDOSCOPIA ENDOSCOPIE ENDOSCOPIA

Scharfe Präparation, Fasszangen  
 Sharp Dissection, Grasping Forceps  
 Disección punta, Pinzas de aprehensión  
 Dissection tranchant, Pincas à Préhension  
 Dissezione tagliente, Pinze da presa

Ø 3,0 mm, 1-teilig / 1-piece



			20,0 cm/8"	33,0 cm/13"
	<sup>1/n</sup>	Ø 3,0 mm	XM 070/20	XM 070/33
METZENBAUM				
	<sup>1/n</sup>	Ø 3,0 mm	XM 071/20	XM 071/33
HAKENSCHERE HOOK SCISSORS				
	<sup>1/n</sup>	Ø 3,0 mm	XM 072/20	XM 072/33
STANZE PUNCH				
	<sup>1/n</sup>	Ø 3,0 mm	XM 073/20	XM 073/33
METZENBAUM GERADE METZENBAUM STRAIGHT				
	<sup>1/n</sup>	Ø 3,0 mm	XM 074/20	XM 074/33
METZENBAUM GEBOGEN GEZAHNT METZENBAUM CURVED SERRATED				
	<sup>1/n</sup>	Ø 3,0 mm	XM 080/20	XM 080/33
GREIFZANGE GRASPING FORCEPS				







ENDOSKOPIE ENDOSCOPY ENDOSCOPIA ENDOSCOPIE ENDOSCOPIA

Fasszangen  
Grasping Forceps  
Pinzas de aprehensión  
Pincas à préhension  
Pinze da presa

Ø 3,0 mm, 1-teilig / 1-piece



	1/1	Ø 3,0 mm	20,0 cm/8"	33,0 cm/13"	XM 081/20	XM 081/33
KELLY ZANGE KELLY FORCEPS						
	1/1	Ø 3,0 mm	XM 082/20	XM 082/33		
MARYLAND						
	1/1	Ø 3,0 mm	XM 083/20	XM 083/33		
ATRAUMATISCHER DISSEKTOR ATRAUMATIC DISSECTOR						
	1/1	Ø 3,0 mm	XM 084/20	XM 084/33		
GREIFZANGE GRASPING FORCEPS						
	1/1	Ø 3,0 mm	XM 085/20	XM 085/33		
GREIFZANGE COBRA GRASPING FORCEPS COBRA						
	1/1	Ø 3,0 mm	XM 086/20	XM 086/33		
FASSZANGE DELPHIN GRASPING FORCEPS DOLPHIN						

1

3

5

7

9

12

14

16

18

20





22

3 ENDOSKOPIE ENDOSCOPY ENDOSCOPIA ENDOSCOPIE ENDOSCOPIA

Fasszangen  
Grasping Forceps  
Pinzas de aprehensión  
Pincas à préhension  
Pinze da presa

Ø 3,0 mm, 1-teilig / 1-piece



			20,0 cm/8"	33,0 cm/13"
	1/1	Ø 3,0 mm	XM 087/20	XM 087/33
LÖFFEL SPOON				
	1/1	Ø 3,0 mm	XM 088/20	XM 088/33
FASSZANGE GRASPING FORCEPS				
	1/1	Ø 3,0 mm	XM 089/20	XM 089/33
FASSZANGE GEFENSTERT GRASPING FORCEPS FENESTRATED				
	1/1	Ø 3,0 mm	XM 095/20	XM 095/33
NADELHALTER RECHTS GEBOGEN NEEDLE HOLDER CURVED RIGHT				
	1/1	Ø 3,0 mm	XM 096/20	XM 096/33
NADELHALTER LINKS GEBOGEN NEEDLE HOLDER CURVED LEFT				

Erwachsene  
Adults  
Adultos  
Adultes  
Adulti

# easyClean<sup>®</sup>

Ø 5,0 mm, 10,0 mm, 3-teilig / 3-piece



XM 010/00



XM 014/00



	L			L		
Ø 5,0 mm	26,0 cm/10"	XM 020/26	Ø 10,0 mm	26,0 cm/10"	XM 021/26	
Ø 5,0 mm	33,0 cm/13"	XM 020/33	Ø 10,0 mm	33,0 cm/13"	XM 021/33	
Ø 5,0 mm	45,0 cm/18"	XM 020/45	Ø 10,0 mm	45,0 cm/18"	XM 021/45	

höchste Präzision und Qualität >> maximum precision and quality standards



Bestellinformation: Bestellen Sie bitte Griff, Schaft und Arbeitseinsatz  
Ordering information: Please order handle, shaft and working tip

1  
3  
5  
7  
9  
12  
14  
16  
18  
20  
22

# easyClean<sup>®</sup>

Ø 5,0 mm, 10,0 mm, 3-teilig / 3-piece



XM 016/00



	L			L	
Ø 5,0 mm	26,0 cm/10"	XM 020/26	Ø 10,0 mm	26,0 cm/10"	XM 021/26
Ø 5,0 mm	33,0 cm/13"	XM 020/33	Ø 10,0 mm	33,0 cm/13"	XM 021/33
Ø 5,0 mm	45,0 cm/18"	XM 020/45	Ø 10,0 mm	45,0 cm/18"	XM 021/45

höchste Präzision und Qualität >> maximum precision and quality standards



Bestellinformation: Bestellen Sie bitte Griff, Schaft und Arbeitseinsatz  
 Ordering information: Please order handle, shaft and working tip

Biopsie  
Biopsy  
Biopsia  
Biopsie  
Biopsia

# easyClean<sup>®</sup>

Ø 5,0 mm, 10,0 mm, 3-teilig / 3-piece

1

3



5



LÖFFEL  
SPOON

1/1

Ø 5,0 mm

33,0 cm/13"

XM 100/32

45,0 cm/18"

XM 100/45

7



LÖFFEL MIT DORN  
SPOON WITH THORN

1/1

Ø 5,0 mm

XM 102/32

XM 102/45

12



STANZE  
PUNCH

1/1

Ø 5,0 mm

XM 104/32

XM 104/45

16



STANZE MIT DORN  
PUNCH WITH THORN

1/1

Ø 5,0 mm

XM 106/32

XM 106/45

18

20



HAKENSTANZE  
HOOK PUNCH

1/1

Ø 5,0 mm

XM 108/32

XM 108/45

22



MIKRO LÖFFEL  
MICRO SPOON

1/1

Ø 5,0 mm

XM 110/32

XM 110/45



LÖFFEL  
SPOON

1/1

Ø 10,0 mm

XM 112/32

XM 112/45