

gynäkologie, geburtshilfe, urologie
gynecology, obstetrics, urology
ginecología, obstetricia, urología
gynécologie, obstétrique, urologie
ginecologia, ostetrica, urologia

nopa[®] instruments

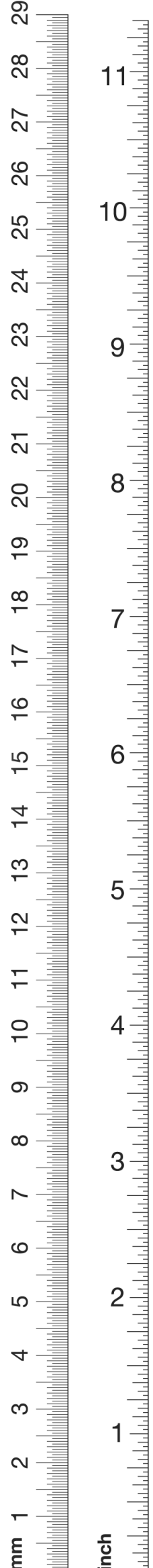



Dies ist unser Katalog, er bleibt unser ausschließliches Eigentum. Es gelten unsere allgemeinen Lieferbedingungen. Sie finden diese auf unserer Internetseite: www.nopa-instruments.com.

This is our Catalogue. It remains our exclusive property. Please find our "General Terms of Sale" on our corporate website: www.nopa-instruments.com.

Esto es nuestro catálogo queda nuestra propiedad. Nuestras condiciones generales de venta se encuentran en nuestra página web: www.nopa-instruments.com.

Voilà notre catalogue et il demeure notre propriété. Veuillez consulter nos conditions générales de vente sur notre page Internet: www.nopa-instruments.com.

Questo è nostro catalogo e rimane nostra proprietà. Trovano applicazione le nostre condizioni generali di fornitura, che sono disponibili sul nostro sito: www.nopa-instruments.com.

Modelländerungen vorbehalten. Nachdruck, auch auszugsweise, verboten.
Change of design and pattern reserved. Re-printing, even in extracts, not permitted.
Nos reservamos el derecho de modificaciones sin aviso previo. Reimpresión, también parcialmente, está prohibido.
Tous droits réservés aux changements de modèle. Réimprimer, également partiellement, est interdit.
Noi riserviamo il diritto di effettuare delle modificazioni. Ristampa di divieto anche parziale.



confidence in

nopa[®] instruments

more than

30
YEARS

thank you for choosing

nopa[®] instruments

...you obviously have good taste

CATALOGUES

Bitte fordern Sie unsere
entsprechenden Kataloge an.

Please request for our
appropriate catalogues.

Por favor pidan por nuestros
catálogos apropiados.

Veillez demander nos
catalogues appropriés.

Chieda prego i nostri
cataloghi adatti.

>> Unser Lieferprogramm

Allgemeinchirurgie
Gynäkologie, Geburtshilfe und Urologie
Plastische Chirurgie und HNO
Thorax, Herz und Gefäßchirurgie
Neurochirurgie
Ophthalmologie
Endoskopie
Container und Sterilisation
Dental und Oral

>> Our product range

General Surgery
Gynecology, obstetrics and urology
Plastic Surgery and ENT
Thoracic and cardiovascular surgery
Neurosurgery
Ophthalmology
Endoscopy
Container and Sterilization
Dental and Oral

>> Nuestra gama
de productos

Cirugía general
Ginecología, obstetricia y urología
Cirugía plástica y ORL
Cirugía torácica y cardiovascular
Neurocirugía
Oftalmología
Endoscopia
Contenedor y esterilización
Odontología y oral

>> Notre gamme

Chirurgie générale
Gynécologie, obstétrique et urologie
Chirurgie plastique et ORL
Chirurgie thoracique et cardiovasculaire
Neurochirurgie
Ophtalmologie
Endoscopie
Conteneur et stérilisation
Dental et Oral

>> Nostro programma
di produzione

Chirurgia generale
Ginecologia, ostetricia e urologia
Chirurgia plastica ed ORL
Chirurgia toracica e cardiovascolare
Neurochirurgia
Oftalmologia
Endoscopia
Contentitore e sterilizzazione
Odontoiatria e Orale

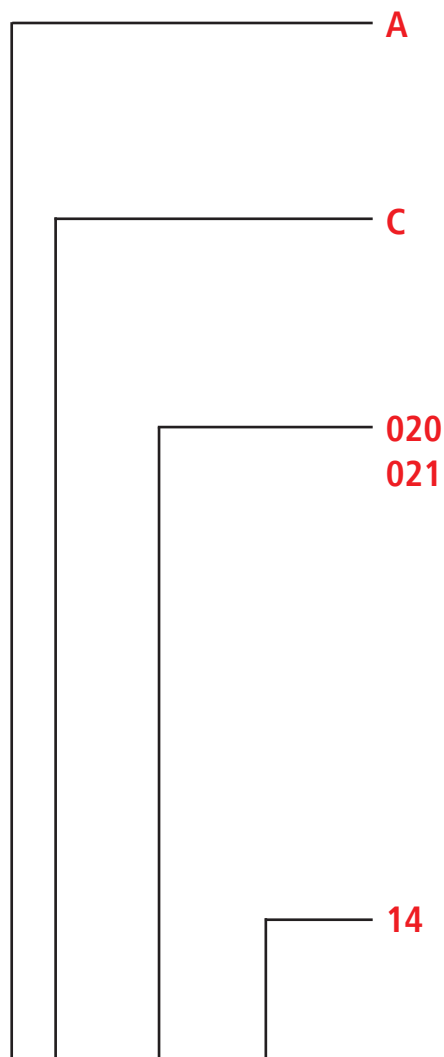

Artikelcode **AC 020/14**

Allgemeines Instrumentarium

General Instruments
Instrumental Général
Instruments Générales
Strumenti generali

Scheren

Scissors
Tijeras
Ciseaux
Forbici

Fortlaufende Nummern

Gerade Ziffer = gerades Instrument
Ungerade Ziffer = gebogenes Instrument

Continuous number

Even number = straight instrument
Odd number = curved instrument

Número de orden

números pares = instrumento derecho
números impares = instrumento curvado

Numéros d'ordre

numéro pair = instrument droit
numéro impair = instrument courbe

Numeri progressivamente

numero pari = strumento retto
numero dispari = strumento curvo

Länge oder Figur

Length or Figure
Longitud o figura
Longueur ou figure
Lunghezza o figura

GYN

Gynecology Sets

ZS 140/00	>> Abdominal Set		9-16
ZS 140/05	>> Vaginal - Hysterectomy		17-24
ZS 140/10	>> Mammoplasty Set		25-30
ZS 140/25	>> Hysteroscopy Endometrial Diagnostic Set		31-36
ZS 140/30	>> Conisation Set		37-42
ZS 140/35	>> Caesarean Section Set		43-48
ZS 140/40	>> Partus Set		49-52
ZS 140/45	>> Delivery Set		53-56
ZS 140/55	>> Dilatation/Curettage Set		57-62
ZS 981/04	>> Hysteroscopy Basic Set	Endoscopy	63-68

URO

Urology Sets

ZS 145/05	>> Nephrectomy Set		69-74
ZS 981/01	>> Resectoscopy Basic Set	Endoscopy	75-78
ZS 981/02	>> Cystoscopy Basic Set	Endoscopy	79-82

For more recommended sets kindly refer to our website

www.nopainstruments.de/produkte



INDEX INSTRUMENTS

>> Klemmen • Hemostats • Pinzas hemostáticas Pinces hémostatiques • Pinze emostatiche	105-136	AA
>> Pinzetten • Forceps • Pinzas • Pinces • Pinze	137-158	AB
>> Scheren • Scissors • Tijeras • Ciseaux • Forbici	159-198	AC
>> Skalpelle • Scalpels • Bisturíes • Bistouris • Bisturi	199-208	AD
>> Naht • Suture • Sutura • Suture • Sutura	209-232	AE
>> Tupferzangen • Sponge Forceps >> Pinzas para pólipos • Pinces à pansements • Pinze per polipi	237-244	AF
>> Wundhaken • Retractors • Separadores • Ecarteurs • Divaricatori	245-288	AK
>> Sonden • Probes • Sondas • Sondes • Sonde	289-296	AL
>> Punktion/Kanülen • Puncture/Special Needles • Punción/Agujas especiales Ponction/Aiguilles spéciales • Puntura/Aghi speciali	297-306	AO
>> Narkose • Anaesthesia • Anestesia • Anesthésie • Anestesia	307-320	AP
>> Diagnostik • Diagnostics • Diagnóstico • Diagnostic • Diagnostica	321-330	AR
>> Gynäkologie/Geburtshilfe • Gynecology/Obstetrics • Ginecologia/Obstetricia Gynécologie/Obstétrique • Ginecologia/Ostetricia	331-388	KB
>> Mammoplastik • Mammoplasty • Mammoplastia Plastie Mammaire • Plastica Mammaria	389-398	KI
>> Urologie • Urology • Urología • Urologie • Urologia	399-418	KC
>> Verschiedenes • Various Items • Diversos Articulos Articles divers • Articoli diversi	419-426	KU
>> Container System • Container System • Sistema de contenedor Système de conteneur • Sistema del contenitore	427-448	KYE
>> Endoskopie • Endoscopy • Endoscopia • Endoscopie • Endoscopia	451-532	X



ABDOMINAL

GYN

SET

ZS 140/00

Siebvorschlag - Suggested instrument set



ZS 140/00 GYNECOLOGY ABDOMINAL SET

Contents:		Qty
AA 200/24	ROCHESTER-PEAN ARTERY FCPS STR 24,0 CM	2
AA 210/24	OCHSNER-KOCHER ART.FCPS.STR 24,0 CM	4
AA 216/14	KOCHER-DELICATE ART.FCPS.STR 1X2T 14,0 CM	10
AA 223/01	OVERHOLT-GEISSENDOERFER FIG.1 27,0 CM	2
AA 335/03	RUMEL FORCEPS FIG.3, 23,0 CM	2
AA 543/01	PARAMETRIUM-CLAMP FIG.1,CVD 24,0 CM	1
AA 543/02	PARAMETRIUM-CLAMP FIG.2,CVD 24,0 CM	1
AA 558/25	NON-TRAUMATIC HAEMORRHOIDAL FORCEPS 25,0 CM	1
AB 060/20	STANDARD TISSUE FCPS. 1X2 T STR 20,0 CM	2
AB 060/25	STANDARD TISSUE FCPS. 1X2 T STR 25,0 CM	2
AB 430/15	GILLIES TISSUE FCPS 1X2 TEETH 15,0 CM	1
AB 862/20	DE BAKEY ATRAUMA FCPS STR 2,0 MM 20,0 CM	2
AB 862/24	DE BAKEY ATRAUMA FCPS STR 2,0 MM 24,0 CM	2
AC 011/15	STANDARD OPER.SCS. CVD.BL/BL 15,5 CM	1
AC 091/20	SIMS SCISSORS CVD BL/BL 20,0 CM	1
AC 919/23	SIMS GYN SCISSORS TUC CVD 23,0 CM	1
AC 941/20	METZENBAUM SCS TUC CVD BL/BL 20,0 CM	1
AC 971/25	METZENBAUM-DELICATE SCS TUC CVD BL/BL 25,0 CM	1
AD 010/04	SCALPEL HANDLE NO.4	2
AE 400/16	MAYO-HEGAR NEEDLE HOLDER TUC 16,0 CM	1
AE 400/20	MAYO-HEGAR NEEDLE HOLDER TUC 20,0 CM	1
AE 400/24	MAYO-HEGAR NEEDLE HOLDER TUC 24,0 CM	1
AE 476/24	BOZEMANN NEEDLE HOLDER TUC S-CVD 24,0 CM	2
AF 100/27	GROSS-MAIER DRESSING FCPS STR 27,0 CM	5
AF 101/27	GROSS-MAIER DRESSING FCPS CURVED 27,0 CM	1
AF 200/25	FOERSTER-BALLENGER STR SERRATED 25,0 CM	2
AF 201/25	FOERSTER-BALLENGER CVD SERRATED 25,0 CM	1
AK 254/75	FRITSCH RETRACTOR 45X75 MM 24,0 CM	2
AK 350/01	ROUX RETRACTOR FIG.1	2
AK 350/03	ROUX RETRACTOR FIG.3	2
AK 804/40	ABDOMINAL SPATULA 33,0 CM	1
AO 820/14	GUIDE NEEDLE 14 CHARR.	1
KB 093/30	BREISKY VAG.SPEC.BAYONET SH.130X30 MM	1
KB 255/25	SCHROEDER FORCEPS BOX LOCK, 25,0 CM	2
KB 262/24	SCHROEDER VULSELLUM FCPS STR 2X2T 24,0 CM	1
KB 265/28	PRATT VULSELLUM FORCEPS 4X4 T. 28,0 CM	1
KK 486/27	DE BAKEY ATRAUMA-KLEMME 27,0 CM	2
KU 300/08	MIXING BOWL 80 x 40 MM	2
KU 302/25	KIDNEY TRAY 250 MM	2
KU 303/65	INNER BOX ONLY FOR NEEDLE CASE ROUND	1
XR 803/05	ELECTRODE HANDLE W. CABLE FOR MARTIN/BERCH	1
XR 841/01	UNIVERSAL-ELECTRODES	1
XR 843/04	UNIVERSAL-ELECTRODES	1
SK 307/05	WIRE BASKET, 540 X 255 X 50 MM	2

Sterilization Container KYE 200/71, if required

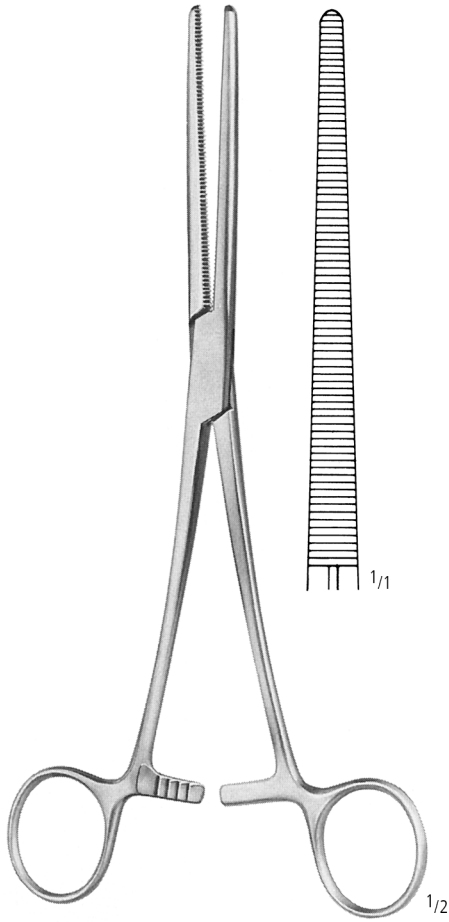

ROCHESTER-PEAN
AA 200/24
24,0 cm/9 1/2"

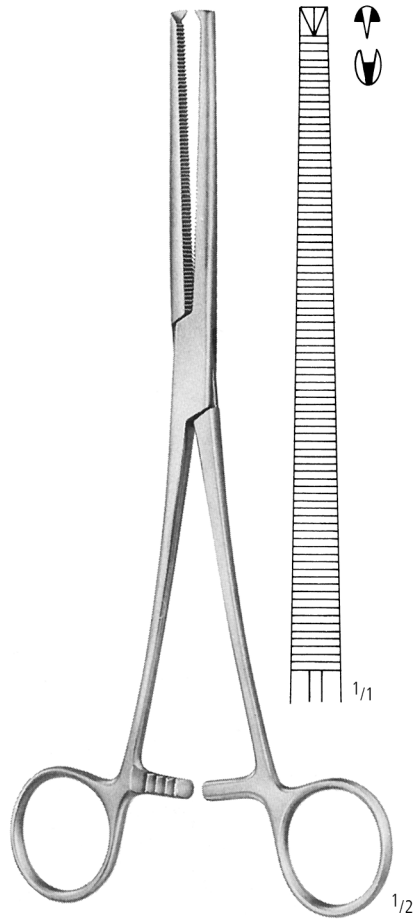

OCHSNER-KOCHER 1:2
AA 210/24
24,0 cm/9 1/2"



KOCHER 1:2 - DELICATE
AA 216/14
14,0 cm/5 1/2"

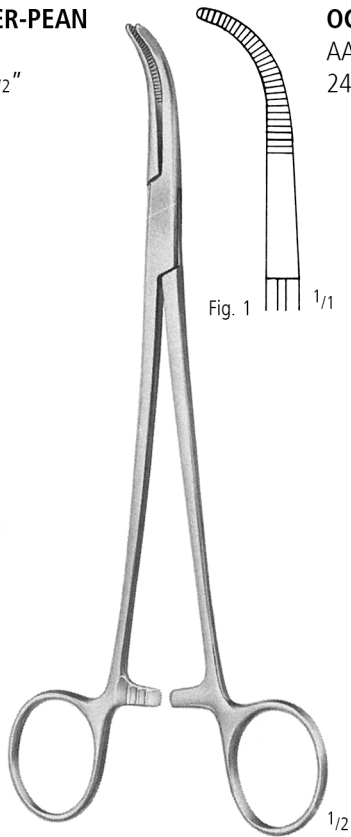

OVERHOLT-GEISSENDOERFER
AA 223/01
27,0 cm/10 3/4"

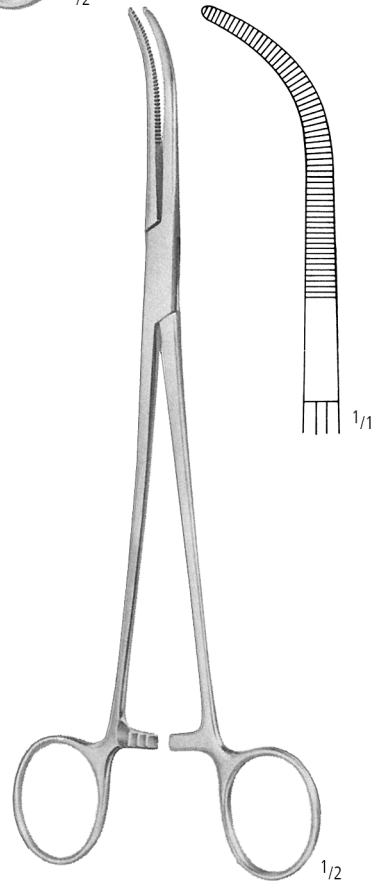

RUMEL
AA 335/03
23,0 cm/9"

ZS 140/00 GYNECOLOGY ABDOMINAL SET

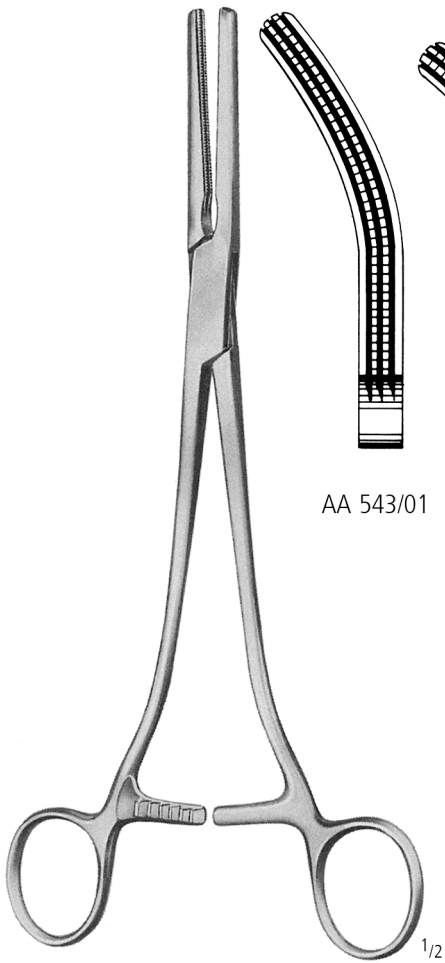

PARAMETRIUM
24,0 cm/9 1/2"

AA 543/01

AA 543/02

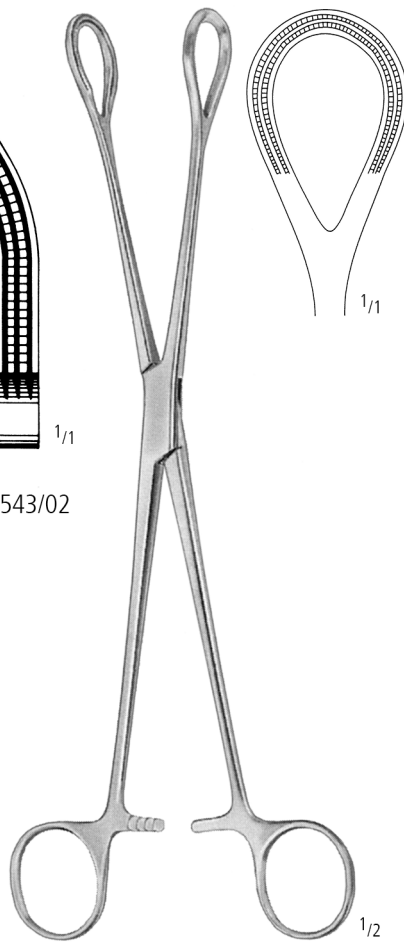

AA 558/25
25,0 cm/10"

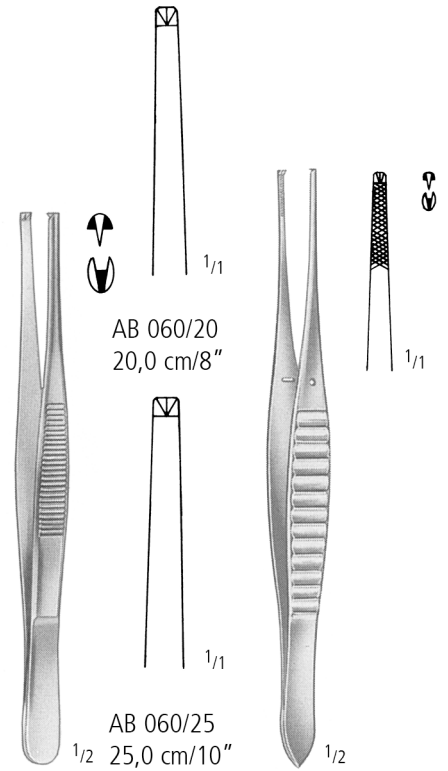

1:2 STANDARD

GILLIES 1:2
AB 430/15
15,0 cm/6"

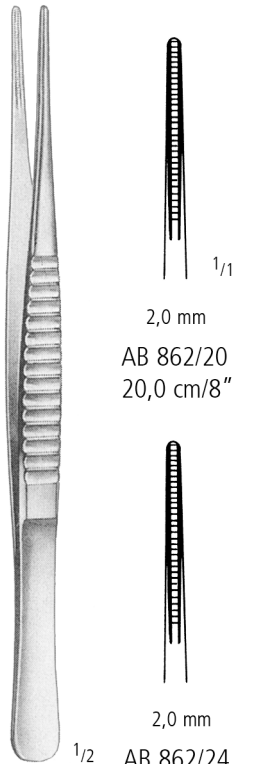

DE BAKEY

AB 862/20
20,0 cm/8"

AB 862/24
24,0 cm/9 1/2"

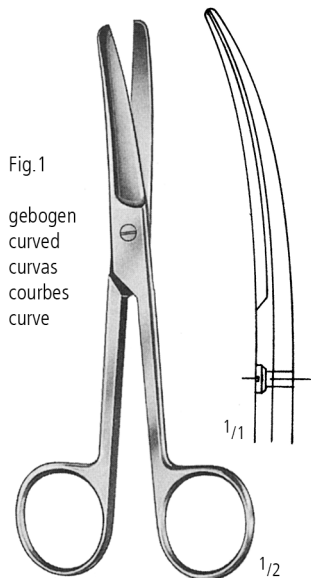

STANDARD
AC 011/15
15,5 cm/6"

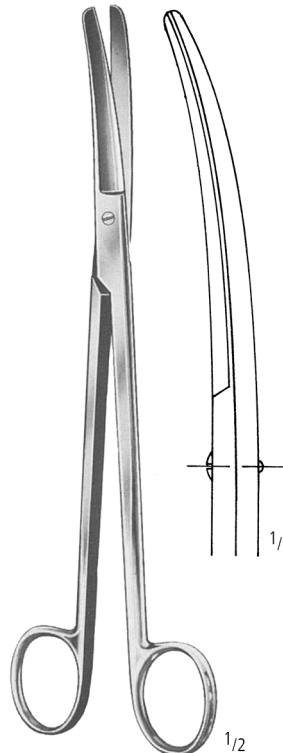

AC 091/20
20,0 cm/8"

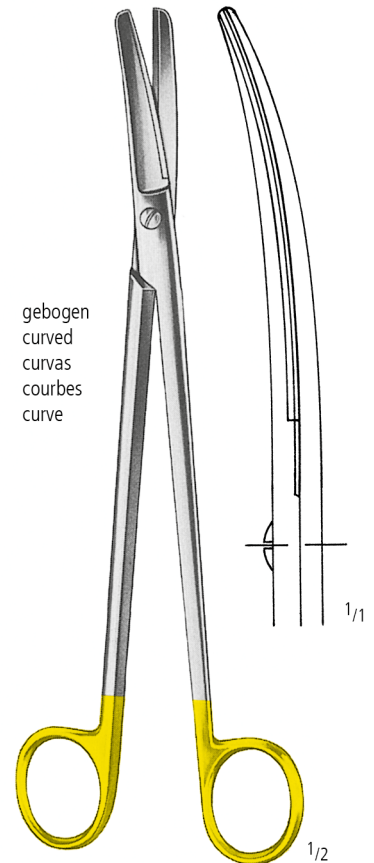

SIMS
AC 919/23
23,0 cm/9"

gebogen
curved
curvas
courbes
curve

Fig.1
gebogen
curved
curvas
courbes
curve

ZS 140/00 GYNECOLOGY ABDOMINAL SET

gebogen
curved
curvas
courbes
curve

gebogen
curved
curvas
courbes
curve

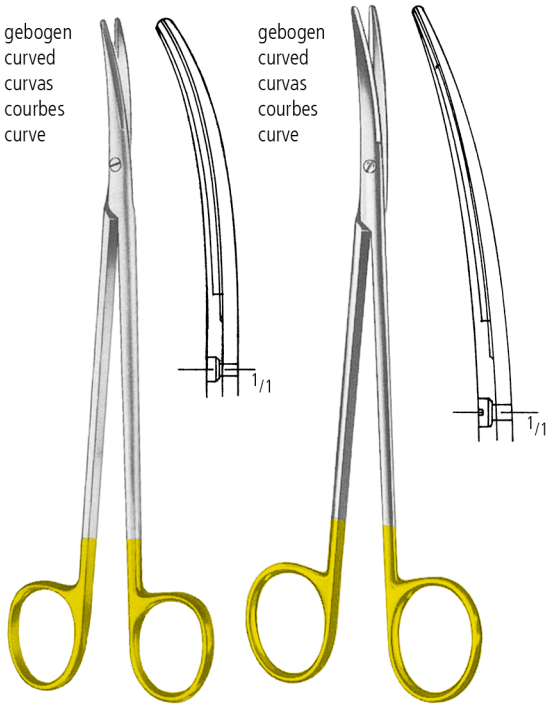

METZENBAUM
AC 941/20
20,0 cm/8"

METZENBAUM-DELICATE
AC 971/25
25,0 cm/10"

AD 010/04
No. 4

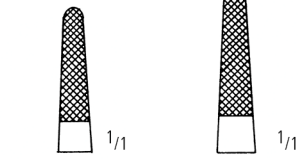

AE 400/16
16,0 cm/6 1/4"

AE 400/20
20,0 cm/8"

AE 400/24
24,0 cm/9 1/2"

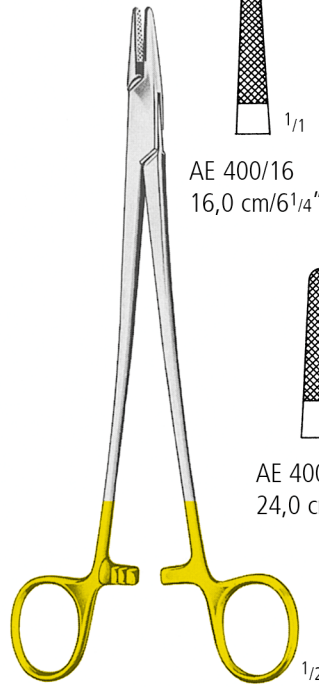

MAYO-HEGAR

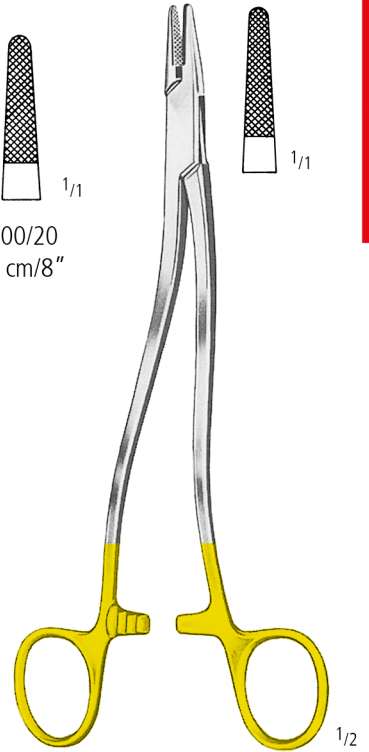

BOZEMANN
AE 476/24
24,0 cm/9 1/2"

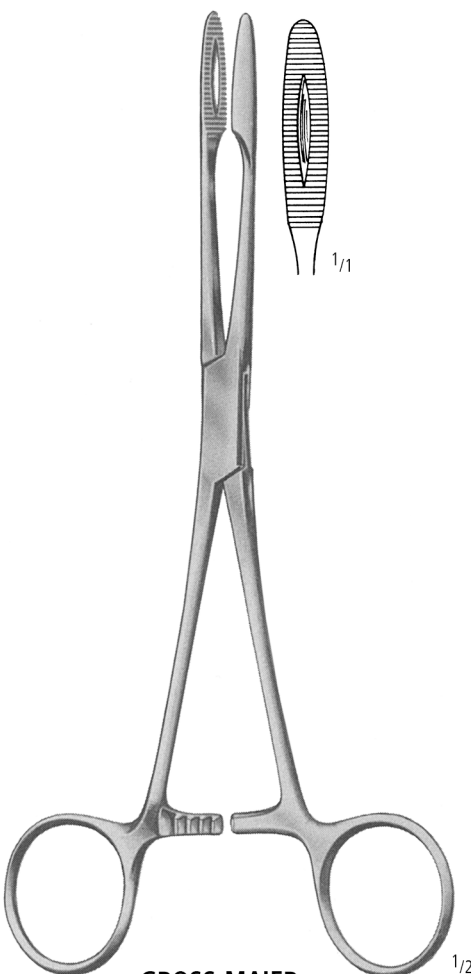

GROSS-MAIER
AF 100/27
27,0 cm/10 3/4"

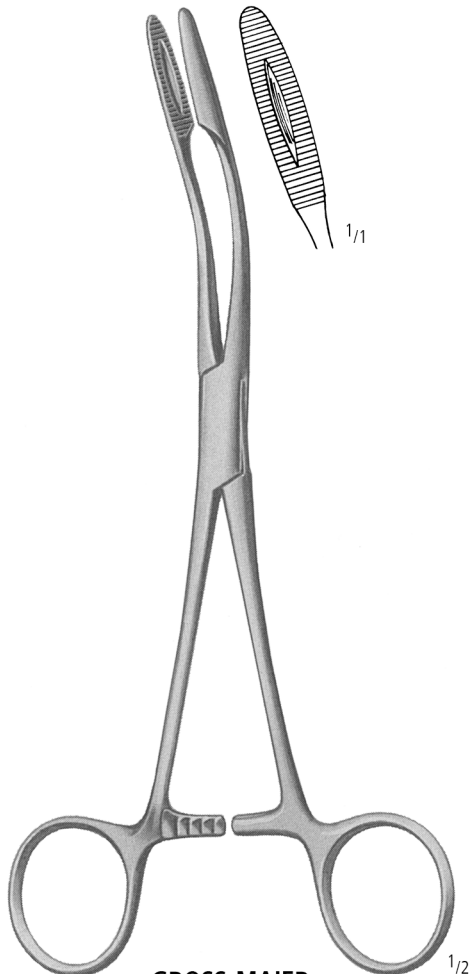

GROSS-MAIER
AF 101/27
27,0 cm/10 3/4"

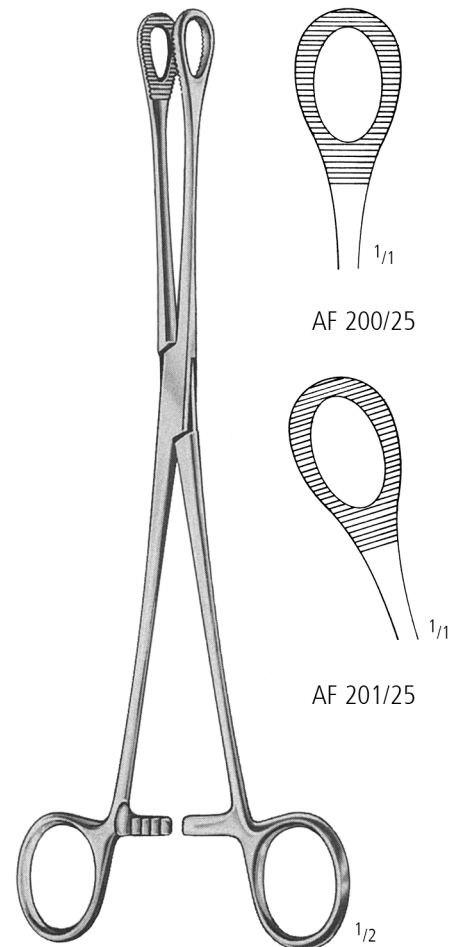

FOERSTER-BALLENGER
25,0 cm/10"

GYN

ZS 140/00

ZS 140/05

ZS 140/10

ZS 140/15

ZS 140/20

ZS 140/25

ZS 140/30

ZS 140/35

ZS 140/40

ZS 140/45

ZS 140/50

ZS 140/55

ZS 140/60

ZS 140/65

ZS 140/70

ZS 140/75

ZS 140/80

ZS 140/85

ZS 140/90

ZS 140/95

ZS 140/00

URO

ZS 981/04

ZS 981/05

ZS 981/06

ZS 981/07

ZS 981/08

ZS 140/00 GYNECOLOGY ABDOMINAL SET

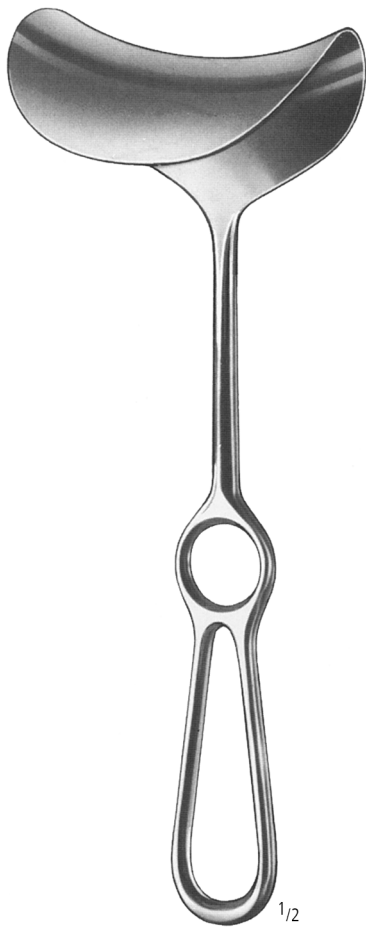

FRITSCH
24,0 cm / 9 1/2"
45 x 75 mm AK 254/75



ROUX
16,5 cm / 6 1/2"
Fig. 1 AK 350/01
Fig. 3 AK 350/03



biegsam
malleable
maleables
malléables
malleabili

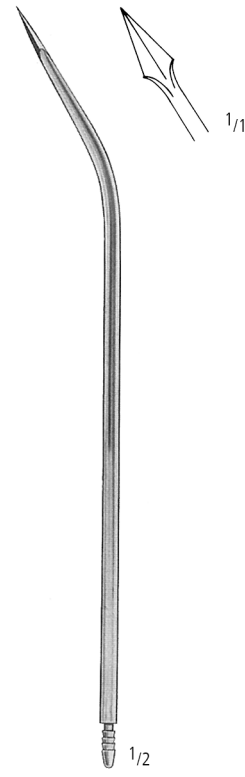

Charr./Fr.
14 AO 820/14



BREISKY
130 x 30 mm
KB 093/30

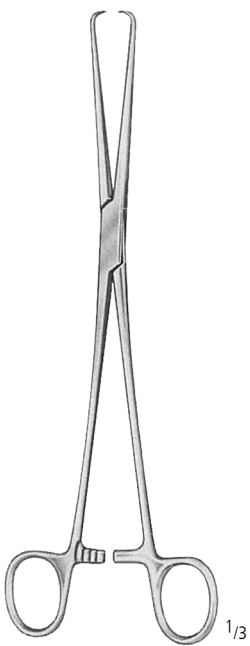

SCHRÖDER
KB 255/25
25,0 cm / 10"

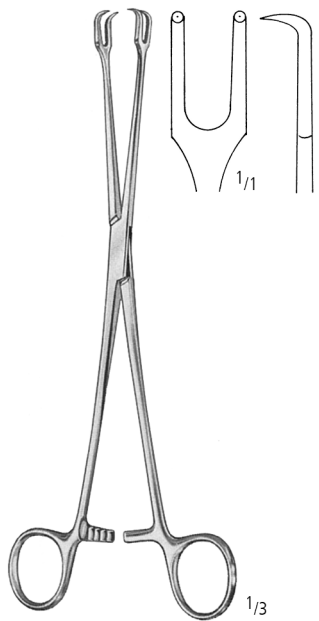

SCHRÖDER
KB 262/24
24,0 cm / 9 1/2"

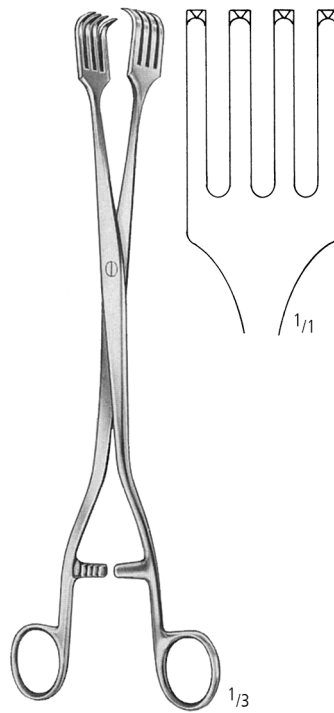

PRATT
KB 265/28
28,0 cm / 11"

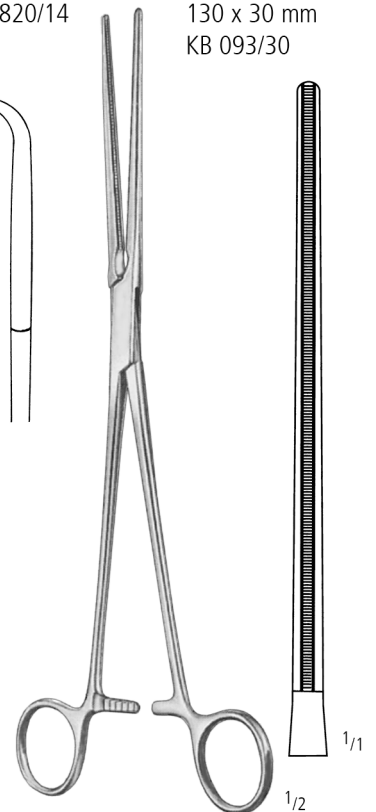

DE BAKEY
KK 486/27
27,0 cm / 10 1/2"

ZS 140/00 GYNECOLOGY ABDOMINAL SET

GYN

ZS 140/00

ZS 140/05

ZS 140/10

ZS 140/15

ZS 140/20

ZS 140/25

ZS 140/30

ZS 140/35

ZS 140/40

ZS 140/45

ZS 140/50

ZS 140/55

ZS 140/60

ZS 140/65

ZS 140/70

ZS 140/75



Ø x h
80 x 40 mm 0,14 l KU 300/08

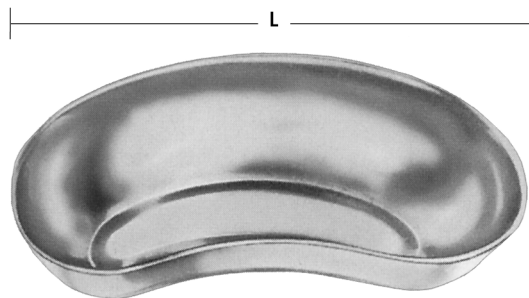

L = 250 mm KU 302/25

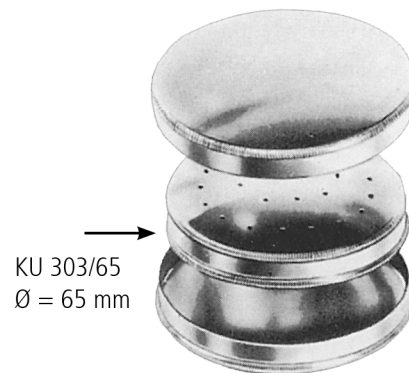

KU 303/65
Ø = 65 mm



MARTIN/BERCHTOLD
XR 803/05



XR 841/01



XR 843/04

URO

ZS 981/04

ZS 981/01

ZS 981/02

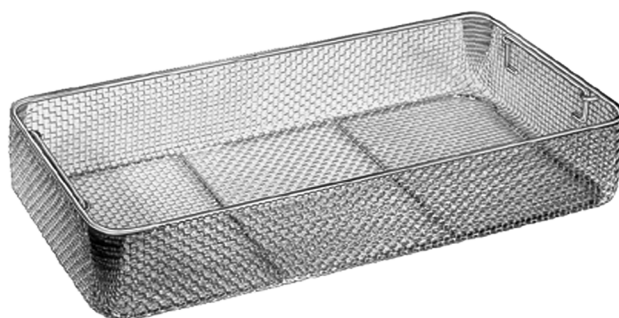

L(mm)	B(mm)	H(mm)	
540	255	50	SK 307/05

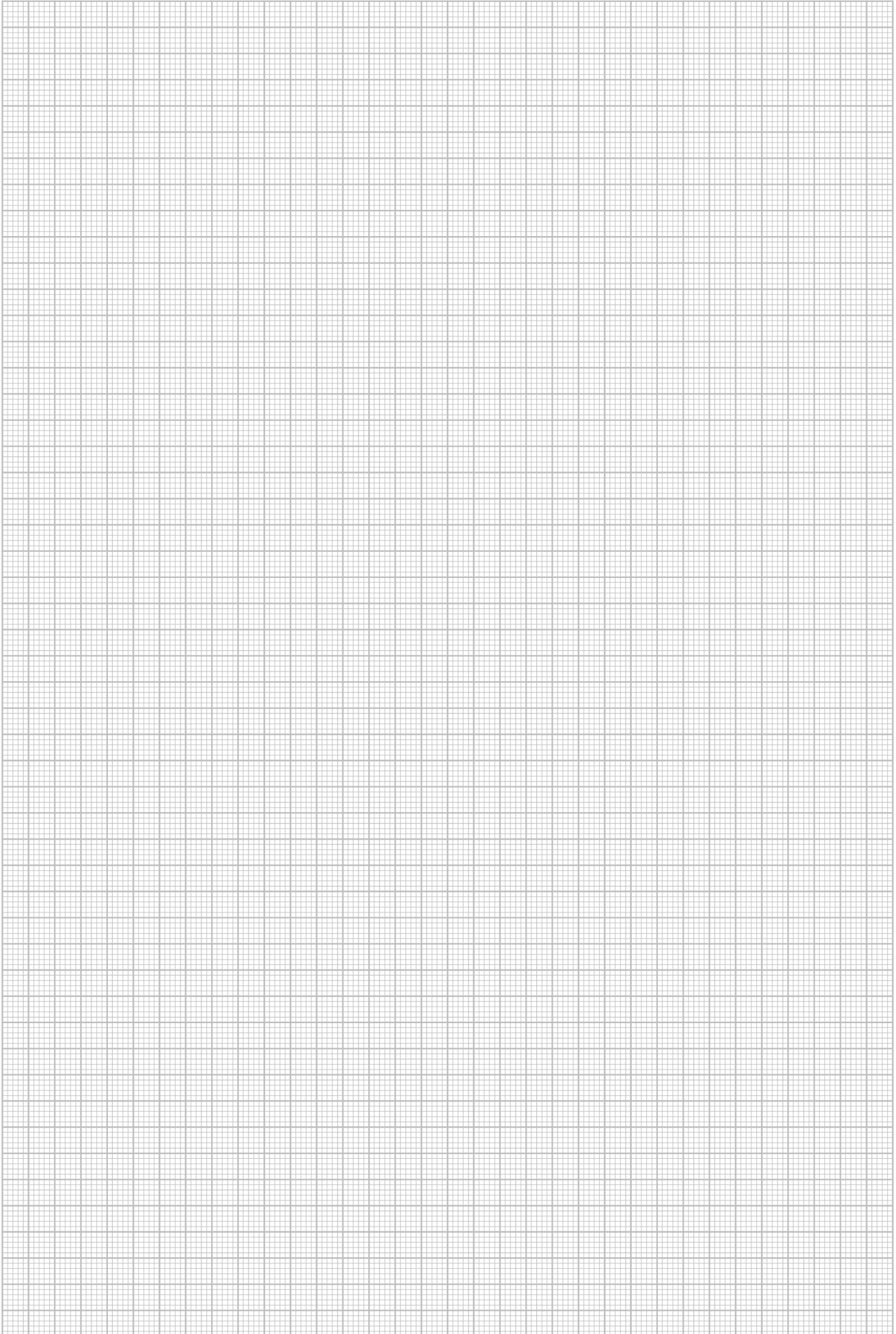

VAGINAL - HYSTERECTOMY

GYN

SET

ZS 140/05

Siebvorschlag - Suggested instrument set



ZS 140/05 VAGINAL-HYSTERECTOMY SET

Contents:		Qty
AA 200/24	ROCHESTER-PEAN ARTERY FCPS STR 24,0 CM	2
AA 210/24	OCHSNER-KOCHER ART.FCPS.STR 24,0 CM	2
AA 211/16	OCHSNER-KOCHER ART.FCPS.CVD 16,0 CM	2
AA 216/14	KOCHER-DELICATE ART.FCPS.STR 1X2T 14,0 CM	6
AA 221/02	OVERHOLT-GEISSENDOERFER FIG.2 21,0 CM	1
AA 223/01	OVERHOLT-GEISSENDOERFER FIG.1 27,0 CM	2
AA 335/04	RUMEL DISS.FORCEPS FIG.4, 23,0 CM	1
AA 543/01	PARAMETRIUM-CLAMP FIG.1,CVD 24,0 CM	1
AA 543/02	PARAMETRIUM-CLAMP FIG.2,CVD 24,0 CM	1
AB 050/20	STANDARD DRESSING FORCEPS STR 20,0 CM	2
AB 060/20	STANDARD TISSUE FCPS. 1X2 T STR 20,0 CM	3
AB 060/25	STANDARD TISSUE FCPS. 1X2 T STR 25,0 CM	1
AC 011/15	STANDARD OPER.SCS. CVD.BL/BL 15,5 CM	1
AC 091/20	SIMS GYNEC. SCISSORS CVD BL/BL 20,0 CM	1
AC 091/23	SIMS GYNEC. SCISSORS CVD BL/BL 23,0 CM	1
AC 941/18	METZENBAUM SCS TUC CVD BL/BL 18,0 CM	1
AC 941/23	METZENBAUM SCS TUC CVD BL/BL 23,0 CM	1
AD 010/04	SCALPEL HANDLE NO.4	2
AE 400/20	MAYO-HEGAR NEEDLE HOLDER TUC 20,0 CM	2
AE 487/24	WERTHEIM NEEDLE HOLDER TUC S-CVD 24,0 CM	2
AF 100/27	GROSS-MAIER DRESSING FCPS STR 27,0 CM	4
AF 201/25	FOERSTER-BALLENGER CVD SERRATED 25,0 CM	1
AK 239/28	MODELL TÜBINGEN RETRACTOR 95X20 MM 28,0 CM	1
KB 062/02	KRISTELLER VAG.SPECULA 110X30MM, FIG.2	1
KB 078/05	SCHERBAK VAGINAL SPECULA,SET COMPLETE	1
KB 093/25	BREISKY VAG.SPEC.BAYONET SH.130X25 MM	1
KB 093/30	BREISKY VAG.SPEC.BAYONET SH.130X30 MM	2
KB 093/40	BREISKY VAG.SPEC.BAYONET SH.130X40 MM	1
KB 201/32	SIMS UTERINE SOUND MALLEABLE"CM" 32,0 CM	1
KB 255/25	SCHROEDER FORCEPS BOX LOCK, 25,0 CM	4
KD 055/15	ALLIS FCPS 5X6T 15,0 CM	8
KU 302/25	KIDNEY TRAY 250 MM	2
KU 303/65	INNER BOX ONLY FOR NEEDLE CASE ROUND	1
XR 803/05	ELECTR HANDLE W. CABLE FOR MARTIN/BERCH	1
XR 841/01	UNIVERSAL-ELECTRODES	1
XR 843/04	UNIVERSAL-ELECTRODES	1
SK 307/05	WIRE BASKET, 540 X 255 X 50 MM	1

Sterilization Container KYE 200/51, if required

ZS 140/05 VAGINAL-HYSTERECTOMY SET

GYN

ZS 140/00

ZS 140/05

ZS 140/10

ZS 140/25

ZS 140/30

ZS 140/35

ZS 140/40

ZS 140/45

ZS 140/55

ZS 981/04

ZS 981/05

ZS 981/06

ZS 981/07

ZS 981/08

ZS 981/09

ZS 981/10

ZS 981/11

ZS 981/12

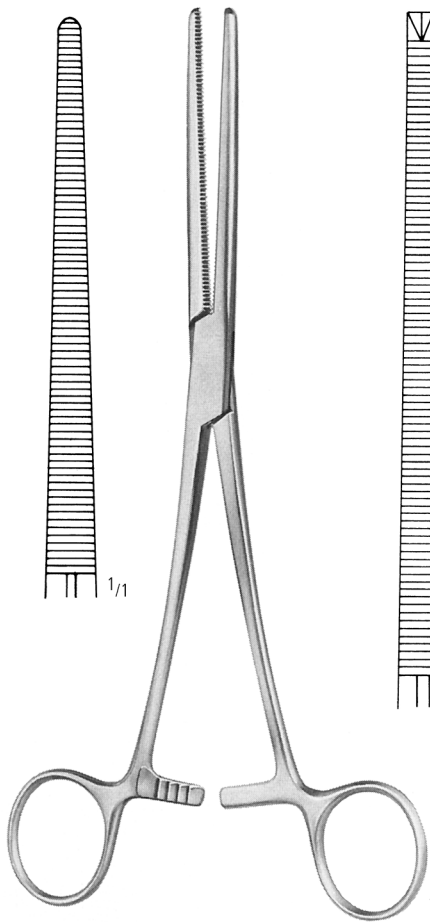

ROCHESTER-PEAN
AA 200/24
24,0 cm/9 1/2"

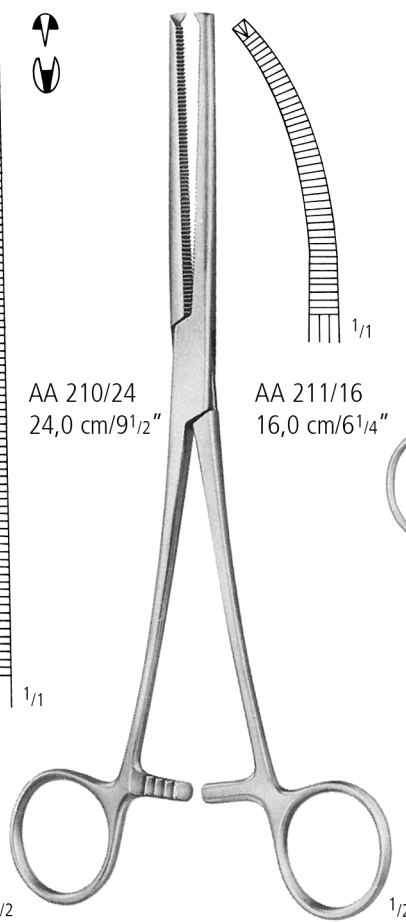

AA 210/24
24,0 cm/9 1/2"

AA 211/16
16,0 cm/6 1/4"

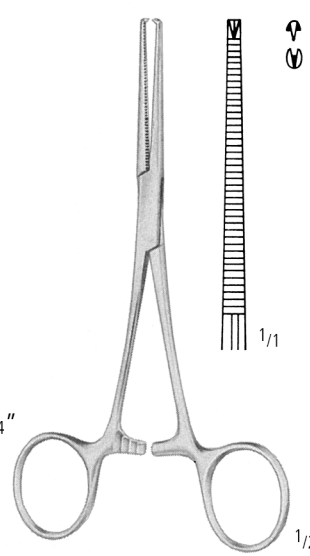

KOCHER 1:2 - DELICATE
AA 216/14
14,0 cm/5 1/2"

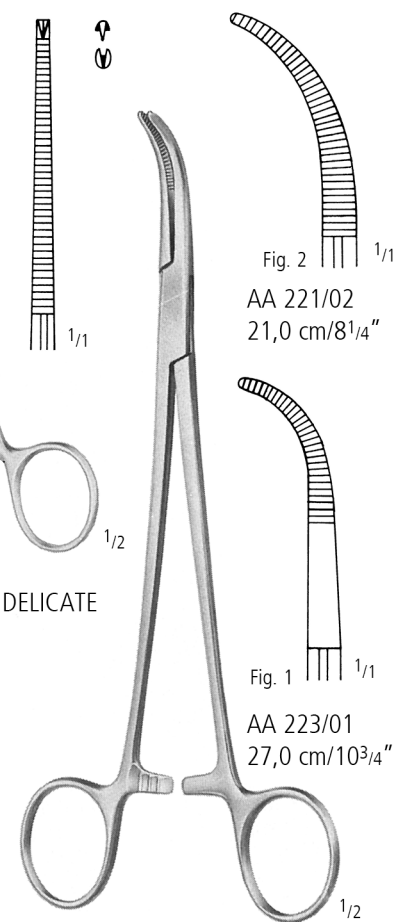
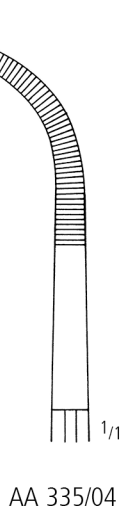

Fig. 2
AA 221/02
21,0 cm/8 1/4"

Fig. 1
AA 223/01
27,0 cm/10 3/4"



RUMEL
23,0 cm/9"



AA 335/04

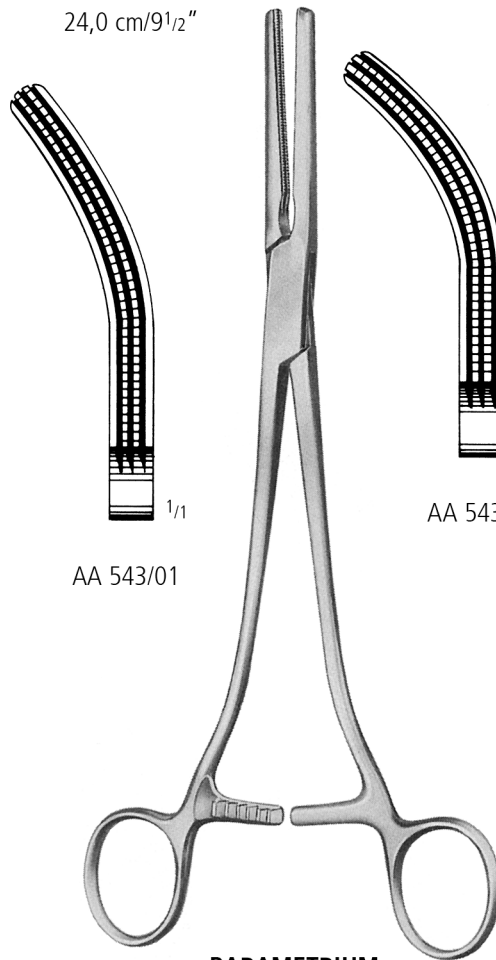

OCHSNER-KOCHER 1:2
24,0 cm/9 1/2"

AA 543/01

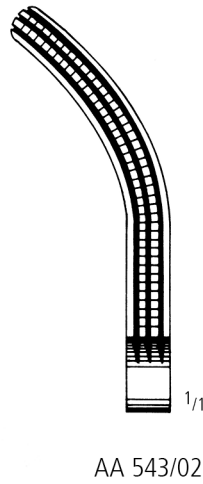

AA 543/02

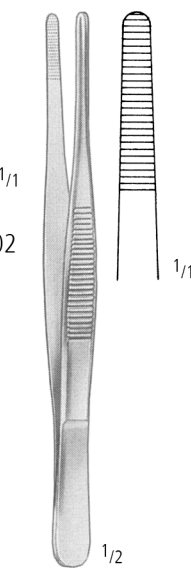

STANDARD
AB 050/20
20,0 cm/8"

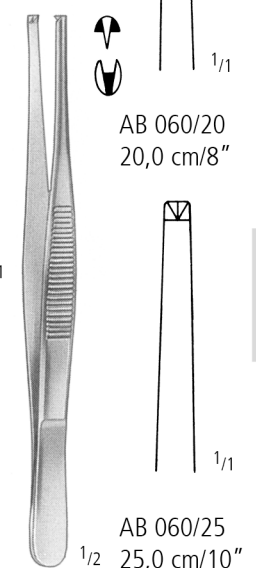

1:2 STANDARD

AB 060/20
20,0 cm/8"

AB 060/25
25,0 cm/10"

URO

ZS 145/05

ZS 981/01

ZS 981/02

ZS 981/12

ZS 140/05 VAGINAL-HYSTERECTOMY SET

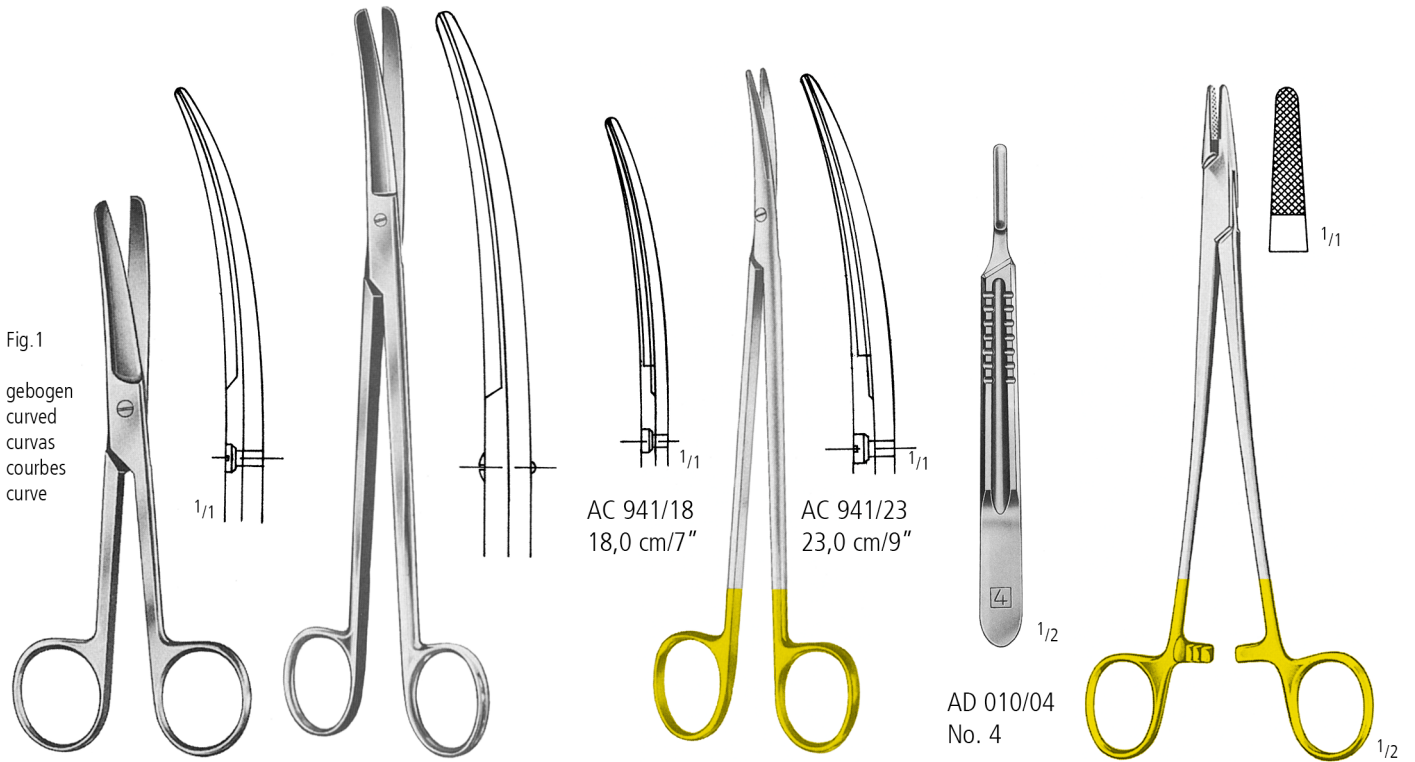

Fig. 1
gebogen
curved
curvas
courbes
curve

STANDARD

AC 011/15
15,5 cm/6"

SIMS

AC 091/20 20,0 cm/8"
AC 091/23 23,0 cm/9"

METZENBAUM

AC 941/18 18,0 cm/7"
AC 941/23 23,0 cm/9"

AD 010/04
No. 4

MAYO-HEGAR

AE 400/20
20,0 cm/8"

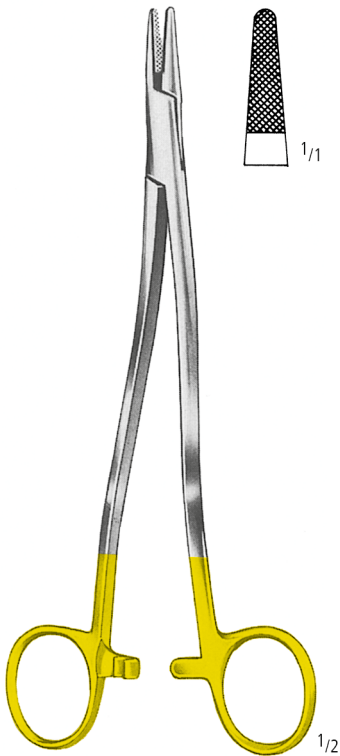

WERTHEIM

AE 487/24
24,0 cm/9 1/2"

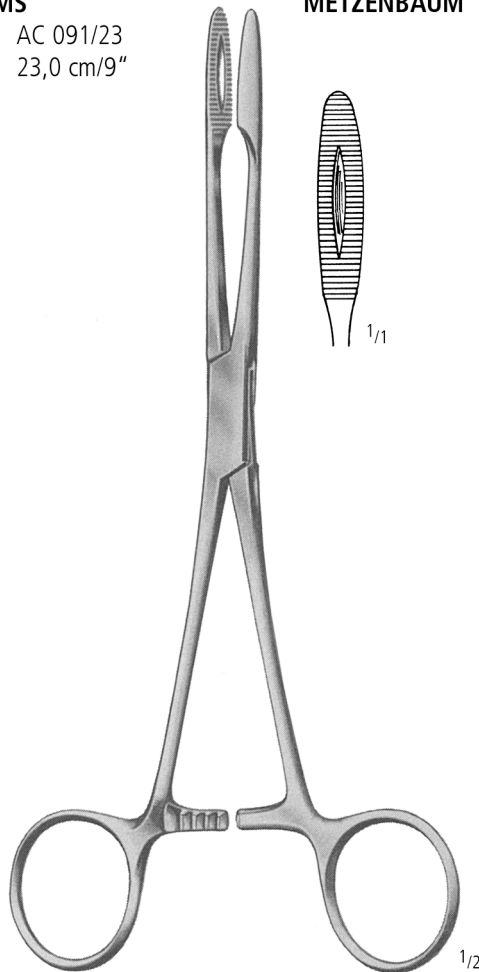

GROSS-MAIER

AF 100/27
27,0 cm/10 3/4"

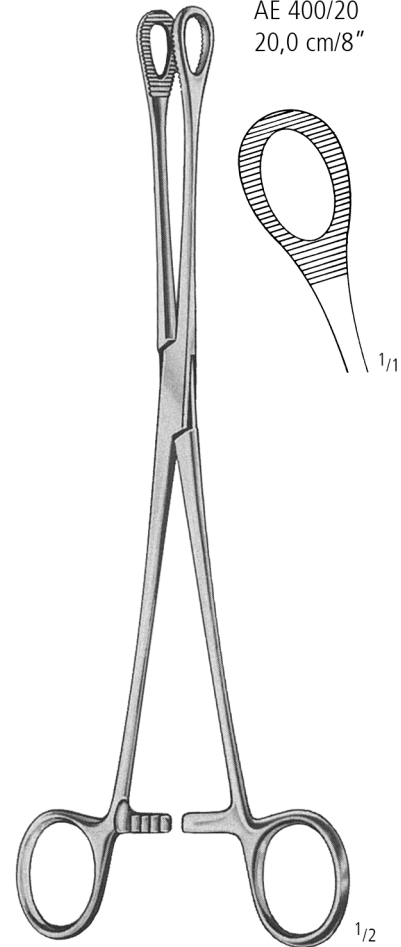

FOERSTER-BALLEGER

AF 201/25
25,0 cm/10"