

allgemeine chirurgie
general surgery
cirugía general
chirurgie générale
chirurgia generale

nopa[®] instruments

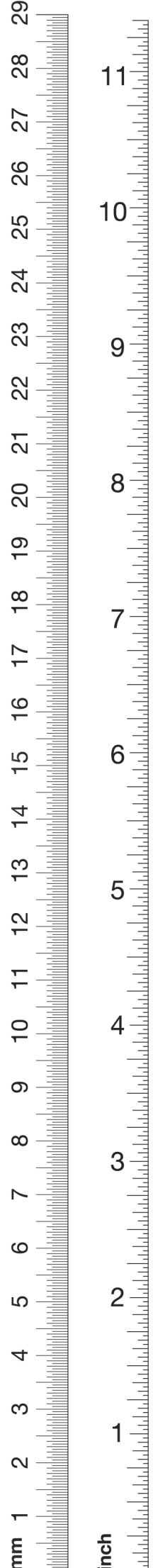



Dies ist unser Hauptkatalog, er bleibt unser ausschließliches Eigentum. Es gelten unsere allgemeinen Lieferbedingungen. Sie finden diese auf unserer Internetseite: www.nopa-instruments.com.

This is our General Catalogue. It remains our exclusive property. Please find our "General Terms of Sale" on our corporate website: www.nopa-instruments.com.

Esto es nuestro catálogo y queda nuestra propiedad. Nuestros condiciones generales de venta se encuentran en nuestra página web: www.nopa-instruments.com.

Voilà notre catalogue et il demeure notre propriété. Veuillez consulter nos conditions générales de vente sur notre page Internet : www.nopa-instruments.com.

Questo è nostro catalogo e rimane nostra proprietà. Trovano applicazione le nostre condizioni generali di fornitura, che sono disponibili sul nostro sito: www.nopa-instruments.com.

Modelländerungen vorbehalten. Nachdruck, auch auszugsweise, verboten.
Change of design and pattern reserved. Re-printing, even in extracts, not permitted.
Nos reservamos el derecho de modificaciones sin aviso previo. Reimpresión, también parcialmente, esta prohibido.
Tous droits réservés aux changements de modèle. Réimprimer, également partiellement, est interdit.
Noi riserviamo il diritto di effettuare delle modificazioni. Ristampa di divieto anche parziale.



confidence in

nopa[®] instruments

more than

35
YEARS

thank you for choosing

nopa[®] instruments

...you obviously have good taste

Bitte fordern Sie unsere
entsprechenden Kataloge an.

Please request for our
appropriate catalogues.

Por favor pidan por nuestros
catálogos apropiados.

Veillez demander nos
catalogues appropriés.

Chieda prego i nostri
cataloghi adatti.

>> Unser Lieferprogramm

Allgemeinchirurgie und Gynäkologie
Plastische Chirurgie und HNO
Cardiovascular
Neurochirurgie
Ophthalmologie
Endoskopie
Behältnisse zur Instrumentensterilisation
Dental und Oral

>> Our product range

General Surgery and Gynecology
Plastic Surgery and ENT
Cardiovascular
Neurosurgery
Ophthalmology
Endoscopy
Sterilizing Containers
Dental and Oral

**>> Nuestro gama
de productos**

Cirugía generales y Ginecología
Cirugía plástica y ORL
Cardiovasculares
Neurocirugía
Oftalmología
Endoscópico
Cajas para esterilización
Odontología y Oral

>> Notre gamme

Chirurgie générale et Gynecologie
Chirurgie plastique et ORL
Cardiovasculaires
Neurochirurgie
Ophtalmologie
Endoscopie
Des boîtes à instruments et pour la stérilisation
Dental et Oral

**>> Nostro programma
di produzione**

Chirurgia generale e Ginecologia
Chirurgia plastica ed ORL
Cardiovascolari
Neurochirurgia
Oftalmologia
Endoscopia
Astucci per la sterilizzazione
Odontoiatria e Orale

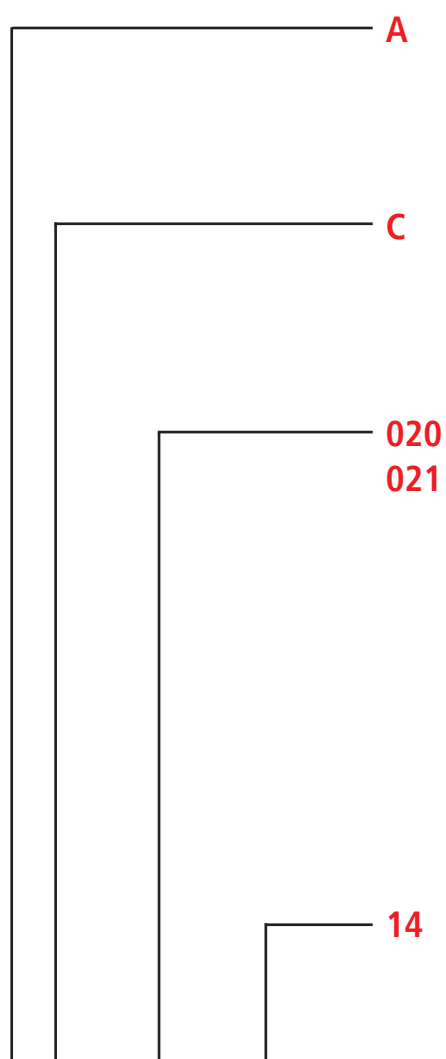

Artikelcode **AC 020/14**

Allgemeines Instrumentarium

General Instruments
Instrumental Général
Instruments Générales
Strumenti generali

Scheren

Scissors
Tijeras
Ciseaux
Forbici

Fortlaufende Nummern

Gerade Ziffer = gerades Instrument
Ungerade Ziffer = gebogenes Instrument

Continuous number

Even number = straight instrument
Odd number = curved instrument

Número de orden

números pares = instrumento derecho
números impares = instrumento curvado

Numéros d'ordre

numéro pair = instrument droit
numéro impair = instrument courbe

Numeri progressivamente

numero pari = strumento retto
numero dispari = strumento curvo

Länge oder Figur

Length or Figure
Longitud o figura
Longueur ou figure
Lunghezza o figura



INDEX

>> Klemmen • Hemostats • Pinzas hemostáticas • Pincas hémostatiques • Pinze emostatiche	7–54	AA
>> Pinzetten • Forceps • Pinzas • Pincas • Pinze	55–98	AB
>> Scheren • Scissors • Tijeras • Ciseaux • Forbici	99–162	AC
>> Skalpelle • Scalpels • Bisturías • Bistouris • Bisturi	163–178	AD
>> Naht • Suture • Sutura • Suture • Sutura	179–226	AE
>> Tupferzangen • Sponge Forceps >> Pinzas para pólipos • Pincas à pansements • Pinze per polipi	227–240	AF
>> Wundhaken • Retractors • Separadores • Ecarteurs • Divaricatori	241–308	AK
>> Sonden • Probes • Sondas • Sondes • Sonde	309–316	AL
>> Verband • Dressing • Vendajes • Pansements • Bendaggi	317–324	AM
>> Punktion/Kanülen • Puncture/Special Needles Punción/Agujas especiales • Ponction/Aiguilles spéciales • Puntura/Aghi speciali	325–340	AO
>> Narkose • Anaesthesia • Anestesia • Anesthésie • Anestesia	351–366	AP
>> Diagnostik • Diagnostics • Diagnóstico • Diagnostic • Diagnostica	367–384	AR
>> Orthopädie • Orthopaedic • Ortopedia • Orthopédie • Ortopedia	385–516	KA
>> Darm/Magen/Mastdarm • Intestines/Stomach/Rectum • Intestinos/Estómago/Recto Intestins/Estomac/Rectum • Intestini/Stomaco/Retto	515–554	KD
>> Verschiedenes • Various items • Diversos Articulos Articles divers • Articoli diversi		
>> Fußpflege • Podiatry • Pedicura • Soins des Pieds • Pedicure	555–580	KU
>> Reinigungsbürsten • Cleaning brushes • Cepillos de limpieza Brosses pour nettoyer • Spazzoli per pulire	581–592	KY



KLEMMEN
HEMOSTATS
PINZAS HEMOSTATICAS
PINCES HEMOSTATIQUES
PINZE EMOSTATICHE

AA

nopa[®] instruments



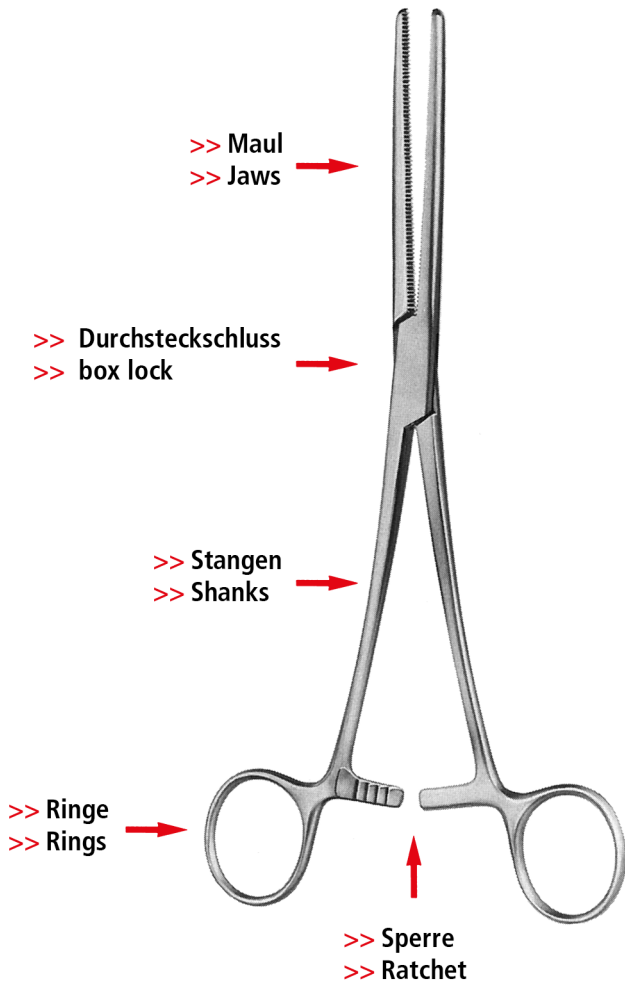

>> Spitzen
>> Tips



>> ohne Zähne
>> without teeth



>> mit Zähnen 1:2
>> with teeth 1:2

>> Maulbiegung
>> jaw curvature

>> Riefung
>> serrations

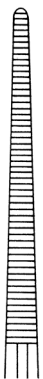

>> gerade
>> straight

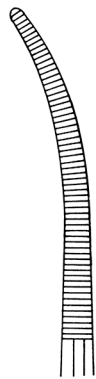

>> gebogen
>> curved



>> quer
>> horizontal



>> längs
>> longitudinal



>> kreuz
>> cross

Gewebefasszängchen, Darmfasszangen
 Tissue Seizing Forceps
 Pinzas para coger tejidos e intestinos
 Pincers pour saisir le tissu et l'intestin
 Pinze per afferrare tessuti e l'intestino

AA
 AB
 AC
 AD
 AE
 AF
 AK
 AL
 AM
 AO
 AP
 AR
 KA
 KD
 KU
 KY

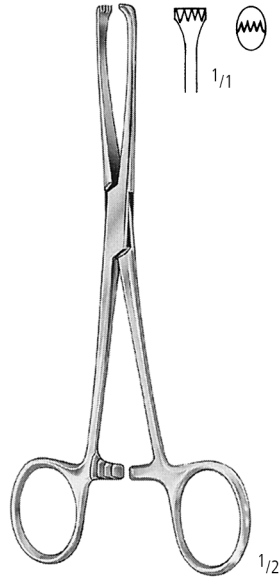

ALLIS 4:5
KD 054/15
 15,0 cm/6"

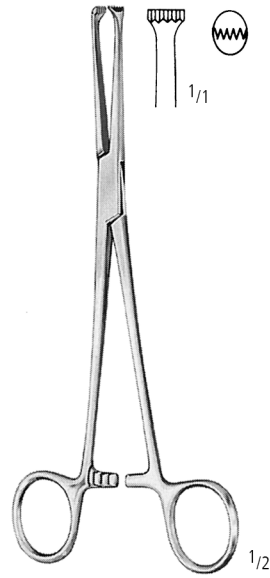

ALLIS 5:6
 15,0 cm/6" **KD 055/15**
 19,0 cm/7 1/2" **KD 055/19**
 25,0 cm/10" **KD 055/25**



BABCOCK



KD 111/16
 16,0 cm/6 1/4"

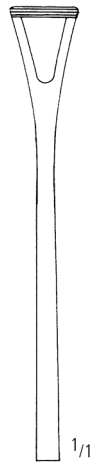

KD 111/18
 18,0 cm/7"

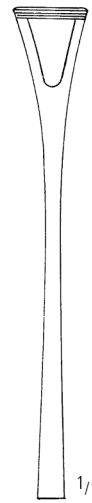

KD 111/20
 20,0 cm/8"

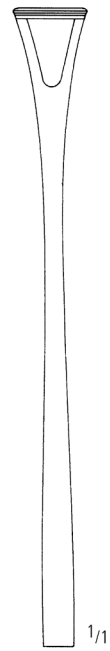

KD 111/24
 24,0 cm/9 1/2"

AA KLEMMEN HEMOSTATS PINZAS HEMOSTATICAS PINCES HEMOSTATIQUES PINZE EMOSTATICHE

Bulldogklemmen
Bulldog Clamps
Clamps Bulldog
Clamps Bulldog
Pinze Bulldog

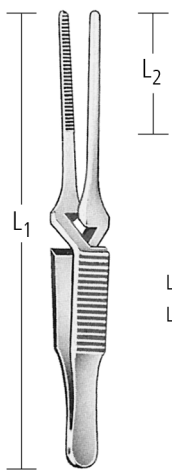

AA 050/01	AA 050/02	AA 050/03	AA 051/01	AA 051/02	AA 051/03
L ₁ 50 mm	50 mm	60 mm	50 mm	50 mm	60 mm
L ₂ 8 mm	12 mm	20 mm	8 mm	12 mm	20 mm

3 gr. 50 gr.
Gewicht Druck
Weight Pressure
Peso Presión
Poids Pression
Peso Pressione

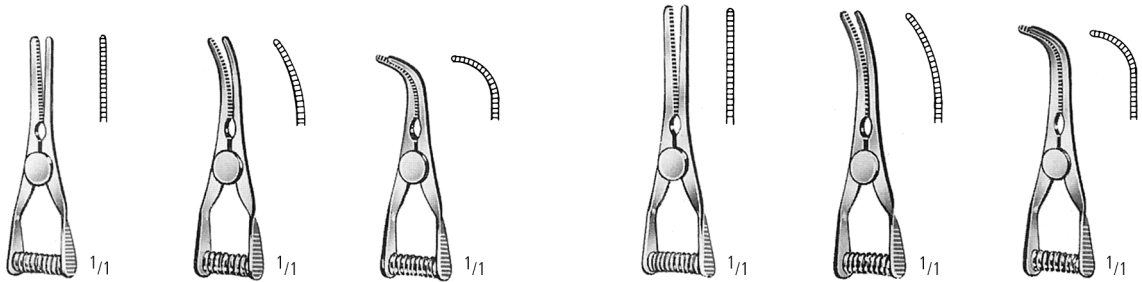

**VENA
ARTERIA**

AA 052/01	TITAN 30 mm	AA 052/03	AA 054/01	TITAN 35 mm	AA 054/03
AA 053/01	AA 052/02	AA 053/03	AA 055/01	AA 054/02	AA 055/03
	AA 053/02			AA 055/02	

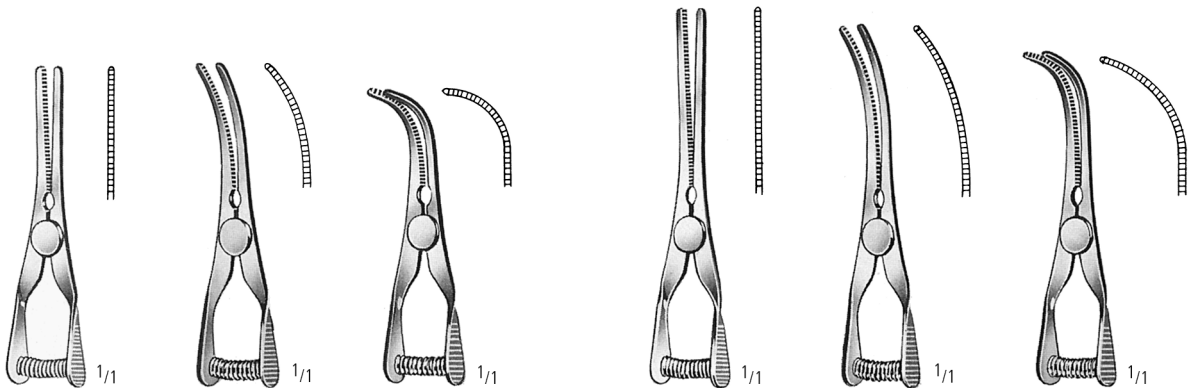

**VENA
ARTERIA**

AA 056/01	TITAN 40 mm	AA 056/03	AA 058/01	TITAN 50 mm	AA 058/03
AA 057/01	AA 056/02	AA 057/03	AA 059/01	AA 058/02	AA 059/03
	AA 057/02			AA 059/02	

Bulldogklemmen, Anlegezange
 Bulldog Clamps, Setting Forceps
 Clamps Bulldog, Pinza para poner
 Clamps Bulldog, Pince à poser
 Pinze Bulldog, Pinza per posizionare

AA
 AB
 AC
 AD
 AE
 AF
 AK
 AL
 AM
 AO
 AP
 AR
 KA
 KD
 KU
 KY



DIEFFENBACH

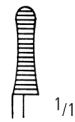

AA 060/03
 3,5 cm/1 1/2"

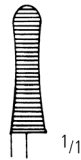

AA 060/05
 5,0 cm/2"

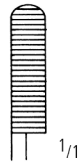

AA 060/06
 6,0 cm/2 1/2"

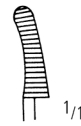

AA 061/03
 3,5 cm/1 1/2"

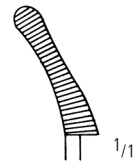

AA 061/05
 5,0 cm/2"

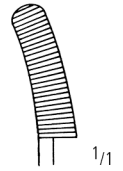

AA 061/06
 6,0 cm/2 1/2"



JOHNS-HOPKINS
AA 069/24
 24,5 cm/9 3/4"

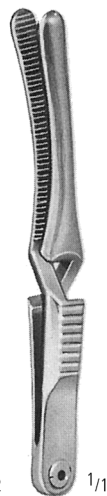

JOHNS-HOPKINS

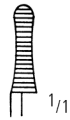

AA 070/04
 4,0 cm/1 1/2"

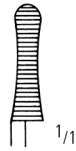

AA 070/05
 5,0 cm/2"

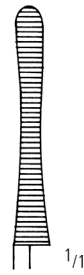

AA 070/06
 6,5 cm/2 1/2"

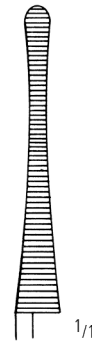

AA 070/07
 7,5 cm/3"

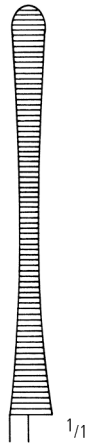

AA 070/09
 9,0 cm/3 1/2"

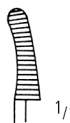

AA 071/04
 4,0 cm/1 1/2"

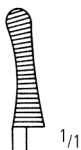

AA 071/05
 5,0 cm/2"

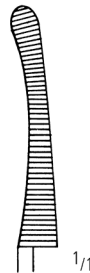

AA 071/06
 6,5 cm/2 1/2"

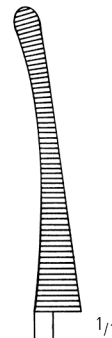

AA 071/07
 7,5 cm/3"

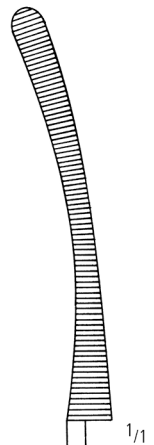

AA 071/09
 9,0 cm/3 1/2"

Fasszangen, Gefäßklemme, Kopfhautklemmen
 Seizing Forceps, Blood Vessel Clamps, Scalp Flap Forceps
 Pinzas para coger, Clamps para vasos, Pinzas hemostáticas para pericráneo
 Pincés à saisir, Pincés vasculaire, Pincés hémostatiques pour le cuir chevelu
 Pinze per afferrare, Pinza per vasi, Pinze emostatiche per il cuoio capelluto



CHAPUT
AA 072/02
 13,0 cm/5"

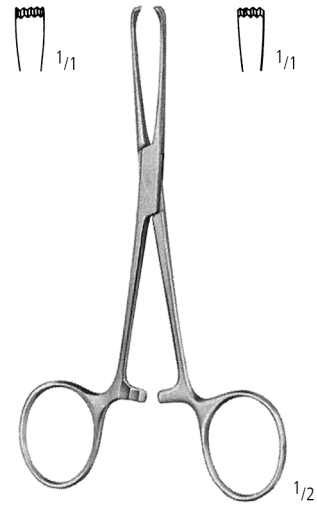

TUFFIER
AA 072/04
 13,0 cm/5"

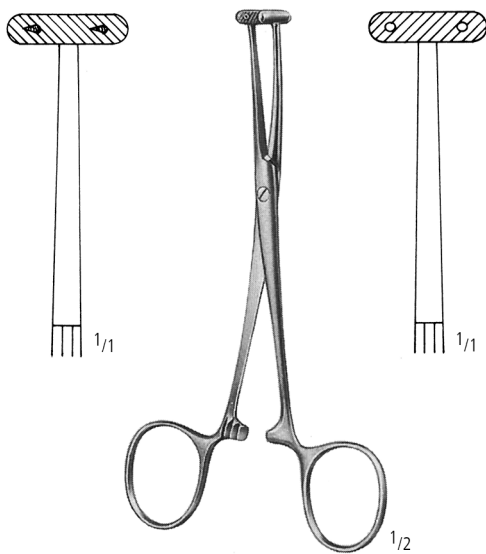

MARTEL
AA 078/14
 14,0 cm/5 1/2"

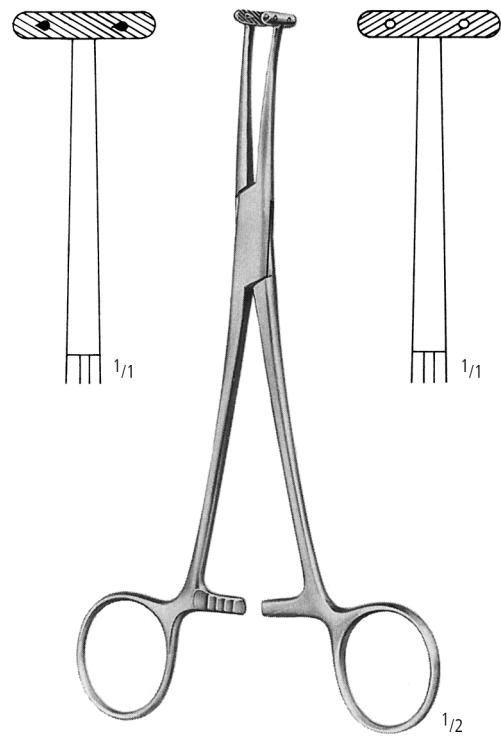

WILLET-MARTEL
AA 078/19
 19,0 cm/7 1/2"

Arterienklemmen, Faszangen
 Artery Forceps, Seizing Forceps
 Pinzas hemostáticas, Pinzas para coger
 Pincés hémostatiques, Pincés à saisir
 Pinze emostatiche, Pinze per afferrare

AA
 AB
 AC
 AD
 AE
 AF
 AK
 AL
 AM
 AO
 AP
 AR
 KA
 KD
 KU
 KY



AA 080/14

AA 080/16

PEAN

14,0 cm/5 1/2"

AA 080/14

16,0 cm/6 1/4"

AA 080/16

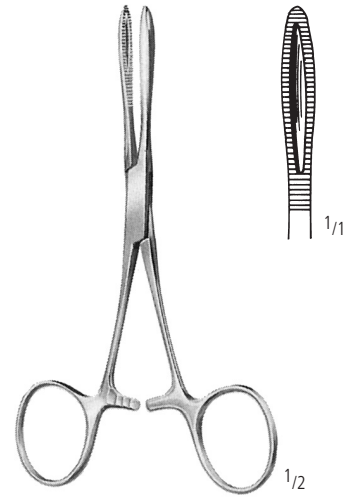

KROENLEIN

AA 082/13

13,0 cm/5"



AA 084/15

PENNINGTON

15,5 cm/6"

AA 084/15

20,0 cm/8"

AA 084/20



COLLIN

AA 090/01

16,0 cm/6 1/4"

AA KLEMMEN HEMOSTATS PINZAS HEMOSTATICAS PINCES HEMOSTATIQUES PINZE EMOSTATICHE

Arterienklemmen
 Artery Forceps
 Pinzas hemostáticas
 Pincas hémostatiques
 Pinze emostatiche



SPENCER-WELLS

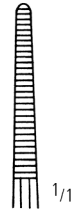

AA 110/13
13,0 cm/5"

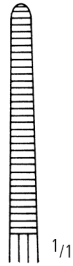

AA 110/14
14,0 cm/5½"

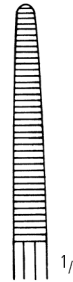

AA 110/15
15,5 cm/6"

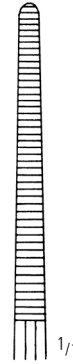

AA 110/18
18,0 cm/7"

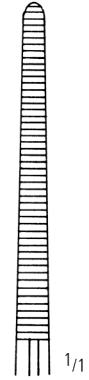

AA 110/20
20,0 cm/8"

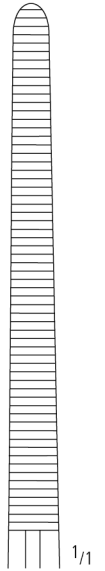

AA 110/36
36,0 cm/14"

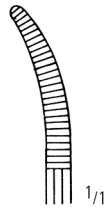

AA 111/13
13,0 cm/5"

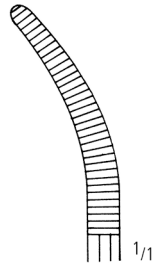

AA 111/14
14,0 cm/5½"

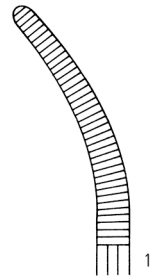

AA 111/15
15,5 cm/6"

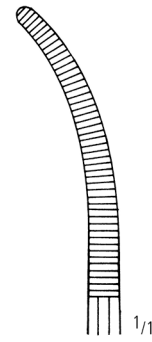

AA 111/18
18,0 cm/7"

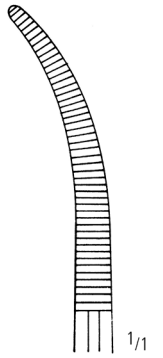

AA 111/20
20,0 cm/8"

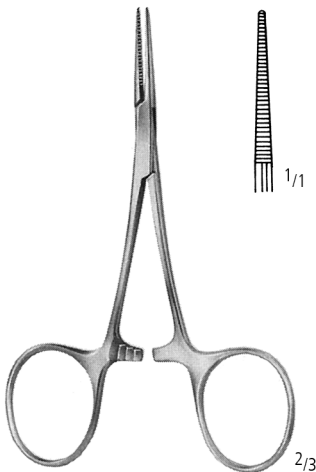

HARTMANN
AA 114/10
10,0 cm/4"

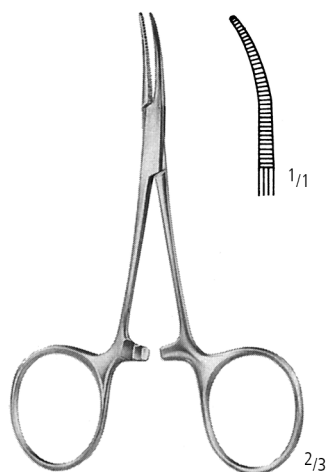

HARTMANN
AA 115/10
10,0 cm/4"

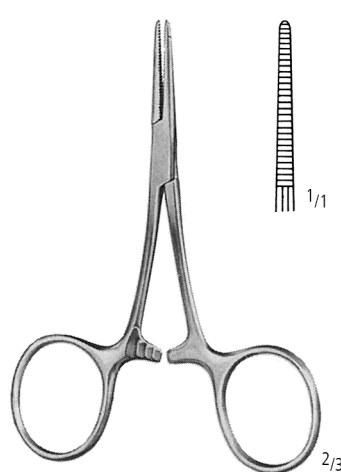

CARREL
AA 116/08
8,5 cm/3½"

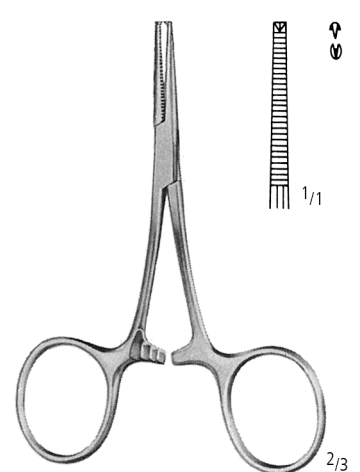

TERRIER 1:2
AA 118/08
8,5 cm/3½"

Feine Arterienklemmen
 Fine Artery Forceps
 Pinzas hemostáticas finas
 Pincas hémostatiques fines
 Pinze emostatiche fine

AA
 AB
 AC
 AD
 AE
 AF
 AK
 AL
 AM
 AO
 AP
 AR
 KA
 KD
 KU
 KY

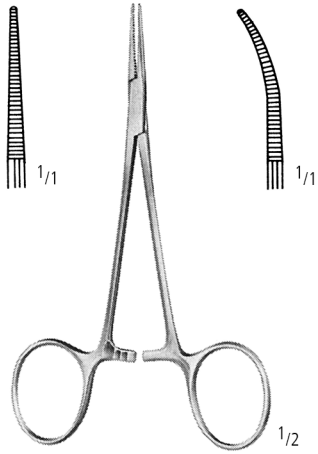

MICRO-MOSQUITO

AA 130/10 AA 131/10
 AA 130/12 AA 131/12

10,0 cm/4"
 12,0 cm/4³/₄"

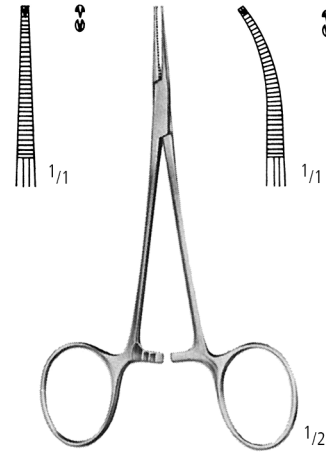

MICRO-MOSQUITO 1:2

AA 132/10 AA 133/10
 AA 132/12 AA 133/12

WILLIAM STEWART HALSTED

was professor of surgery in the Johns Hopkins University. In 1890 he had bronze casts made of his own hands. On these casts the first surgical rubber gloves were moulded.

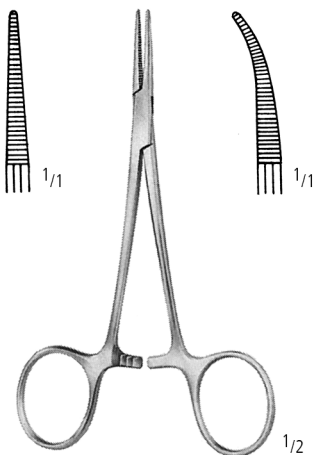

HALSTED-MOSQUITO

AA 150/12 AA 151/12
 AA 150/14 AA 151/14

12,5 cm/5"
 14,0 cm/5¹/₂"

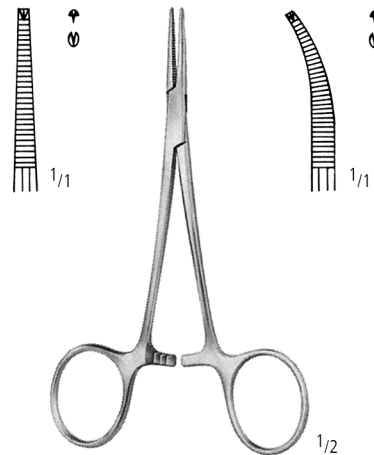

HALSTED-MOSQUITO 1:2

AA 152/12 AA 153/12
 AA 152/14 AA 153/14

Arterienklemmen
 Artery Forceps
 Pinzas hemostáticas
 Pincas hémostatiques
 Pinze emostatiche

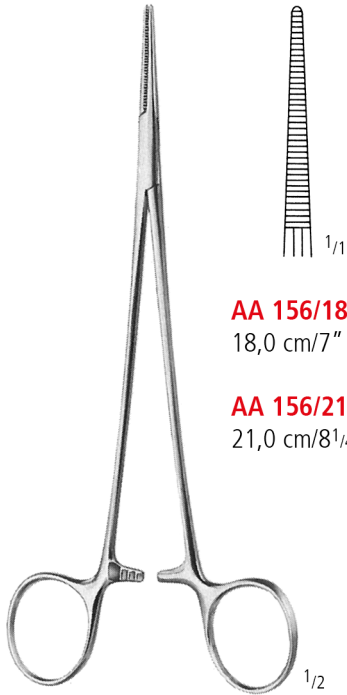

AA 156/18
 18,0 cm/7"

AA 156/21
 21,0 cm/8 1/4"

HALSTED

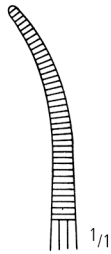

AA 157/18
 18,0 cm/7"

AA 157/21
 21,0 cm/8 1/4"

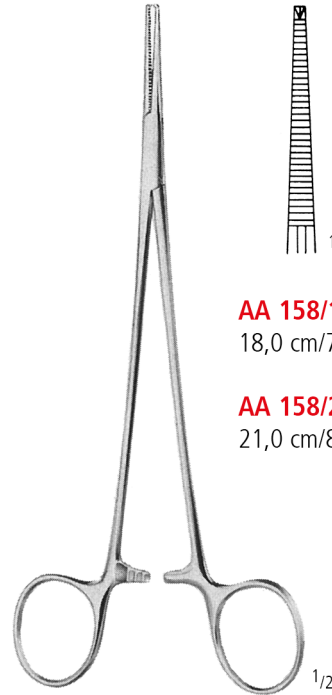

AA 158/18
 18,0 cm/7"

AA 158/21
 21,0 cm/8 1/4"

HALSTED 1:2

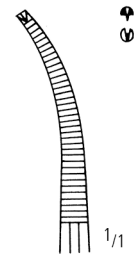

AA 159/18
 18,0 cm/7"

AA 159/21
 21,0 cm/8 1/4"

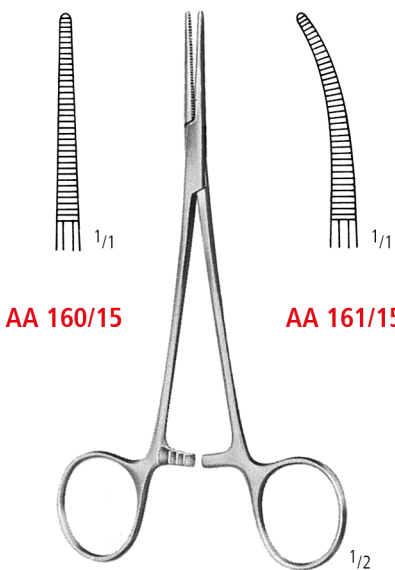

AA 160/15

AA 161/15

LERICHE
 15,0 cm/6"

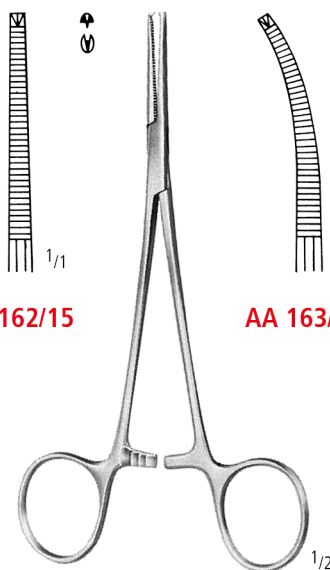

AA 162/15

AA 163/15

LERICHE 1:2
 15,0 cm/6"

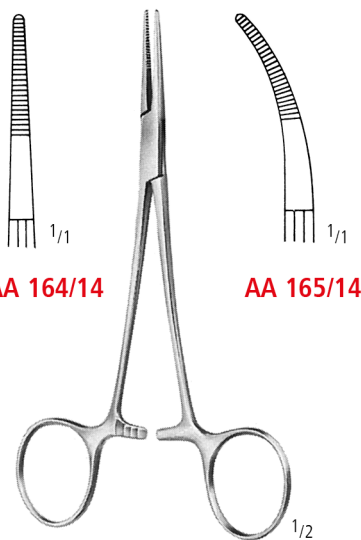

AA 164/14

AA 165/14

PROVIDENCE-HOSPITAL
 14,0 cm/5 1/2"

Arterienklemmen
 Artery Forceps
 Pinzas hemostáticas
 Pincas hémostatiques
 Pinze emostatiche

AA
 AB
 AC
 AD
 AE
 AF
 AG
 AH
 AI
 AJ
 AK
 AL
 AM
 AN
 AO
 AP
 AQ
 AR
 AS
 AT
 AU
 AV
 AW
 AX
 AY
 AZ
 BA
 BB
 BC
 BD
 BE
 BF
 BG
 BH
 BI
 BJ
 BK
 BL
 BM
 BN
 BO
 BP
 BQ
 BR
 BS
 BT
 BU
 BV
 BW
 BX
 BY
 BZ
 CA
 CB
 CC
 CD
 CE
 CF
 CG
 CH
 CI
 CJ
 CK
 CL
 CM
 CN
 CO
 CP
 CQ
 CR
 CS
 CT
 CU
 CV
 CW
 CX
 CY
 CZ
 DA
 DB
 DC
 DD
 DE
 DF
 DG
 DH
 DI
 DJ
 DK
 DL
 DM
 DN
 DO
 DP
 DQ
 DR
 DS
 DT
 DU
 DV
 DW
 DX
 DY
 DZ
 EA
 EB
 EC
 ED
 EE
 EF
 EG
 EH
 EI
 EJ
 EK
 EL
 EM
 EN
 EO
 EP
 EQ
 ER
 ES
 ET
 EU
 EV
 EW
 EX
 EY
 EZ
 FA
 FB
 FC
 FD
 FE
 FF
 FG
 FH
 FI
 FJ
 FK
 FL
 FM
 FN
 FO
 FP
 FQ
 FR
 FS
 FT
 FU
 FV
 FW
 FX
 FY
 FZ
 GA
 GB
 GC
 GD
 GE
 GF
 GG
 GH
 GI
 GJ
 GK
 GL
 GM
 GN
 GO
 GP
 GQ
 GR
 GS
 GT
 GU
 GV
 GW
 GX
 GY
 GZ
 HA
 HB
 HC
 HD
 HE
 HF
 HG
 HH
 HI
 HJ
 HK
 HL
 HM
 HN
 HO
 HP
 HQ
 HR
 HS
 HT
 HU
 HV
 HW
 HX
 HY
 HZ
 IA
 IB
 IC
 ID
 IE
 IF
 IG
 IH
 II
 IJ
 IK
 IL
 IM
 IN
 IO
 IP
 IQ
 IR
 IS
 IT
 IU
 IV
 IW
 IX
 IY
 IZ
 JA
 JB
 JC
 JD
 JE
 JF
 JG
 JH
 JI
 JJ
 JK
 JL
 JM
 JN
 JO
 JP
 JQ
 JR
 JS
 JT
 JU
 JV
 JW
 JX
 JY
 JZ
 KA
 KB
 KC
 KD
 KE
 KF
 KG
 KH
 KI
 KJ
 KK
 KL
 KM
 KN
 KO
 KP
 KQ
 KR
 KS
 KT
 KU
 KV
 KW
 KX
 KY
 KZ
 LA
 LB
 LC
 LD
 LE
 LF
 LG
 LH
 LI
 LJ
 LK
 LL
 LM
 LN
 LO
 LP
 LQ
 LR
 LS
 LT
 LU
 LV
 LW
 LX
 LY
 LZ
 MA
 MB
 MC
 MD
 ME
 MF
 MG
 MH
 MI
 MJ
 MK
 ML
 MM
 MN
 MO
 MP
 MQ
 MR
 MS
 MT
 MU
 MV
 MW
 MX
 MY
 MZ
 NA
 NB
 NC
 ND
 NE
 NF
 NG
 NH
 NI
 NJ
 NK
 NL
 NM
 NN
 NO
 NP
 NQ
 NR
 NS
 NT
 NU
 NV
 NW
 NX
 NY
 NZ
 OA
 OB
 OC
 OD
 OE
 OF
 OG
 OH
 OI
 OJ
 OK
 OL
 OM
 ON
 OO
 OP
 OQ
 OR
 OS
 OT
 OU
 OV
 OW
 OX
 OY
 OZ
 PA
 PB
 PC
 PD
 PE
 PF
 PG
 PH
 PI
 PJ
 PK
 PL
 PM
 PN
 PO
 PP
 PQ
 PR
 PS
 PT
 PU
 PV
 PW
 PX
 PY
 PZ
 QA
 QB
 QC
 QD
 QE
 QF
 QG
 QH
 QI
 QJ
 QK
 QL
 QM
 QN
 QO
 QP
 QQ
 QR
 QS
 QT
 QU
 QV
 QW
 QX
 QY
 QZ
 RA
 RB
 RC
 RD
 RE
 RF
 RG
 RH
 RI
 RJ
 RK
 RL
 RM
 RN
 RO
 RP
 RQ
 RR
 RS
 RT
 RU
 RV
 RW
 RX
 RY
 RZ
 SA
 SB
 SC
 SD
 SE
 SF
 SG
 SH
 SI
 SJ
 SK
 SL
 SM
 SN
 SO
 SP
 SQ
 SR
 SS
 ST
 SU
 SV
 SW
 SX
 SY
 SZ
 TA
 TB
 TC
 TD
 TE
 TF
 TG
 TH
 TI
 TJ
 TK
 TL
 TM
 TN
 TO
 TP
 TQ
 TR
 TS
 TT
 TU
 TV
 TW
 TX
 TY
 TZ
 UA
 UB
 UC
 UD
 UE
 UF
 UG
 UH
 UI
 UJ
 UK
 UL
 UM
 UN
 UO
 UP
 UQ
 UR
 US
 UT
 UY
 UZ
 VA
 VB
 VC
 VD
 VE
 VF
 VG
 VH
 VI
 VJ
 VK
 VL
 VM
 VN
 VO
 VP
 VQ
 VR
 VS
 VT
 VY
 VZ
 WA
 WB
 WC
 WD
 WE
 WF
 WG
 WH
 WI
 WJ
 WK
 WL
 WM
 WN
 WO
 WP
 WQ
 WR
 WS
 WT
 WY
 WZ
 XA
 XB
 XC
 XD
 XE
 XF
 XG
 XH
 XI
 XJ
 XK
 XL
 XM
 XN
 XO
 XP
 XQ
 XR
 XS
 XT
 XU
 XV
 XW
 XX
 XY
 XZ
 YA
 YB
 YC
 YD
 YE
 YF
 YG
 YH
 YI
 YJ
 YK
 YL
 YM
 YN
 YO
 YP
 YQ
 YR
 YS
 YT
 YZ
 ZA
 ZB
 ZC
 ZD
 ZE
 ZF
 ZG
 ZH
 ZI
 ZJ
 ZK
 ZL
 ZM
 ZN
 ZO
 ZP
 ZQ
 ZR
 ZS
 ZT
 ZY
 ZZ

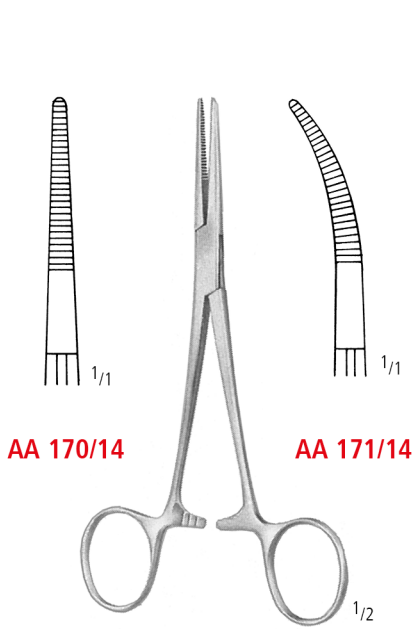

AA 170/14

AA 171/14

KELLY
 14,0 cm/5 1/2"

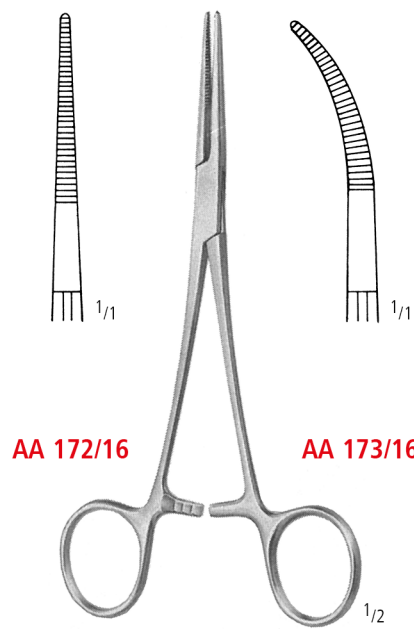

AA 172/16

AA 173/16

KELLY-RANKIN
 16,0 cm/6 1/4"

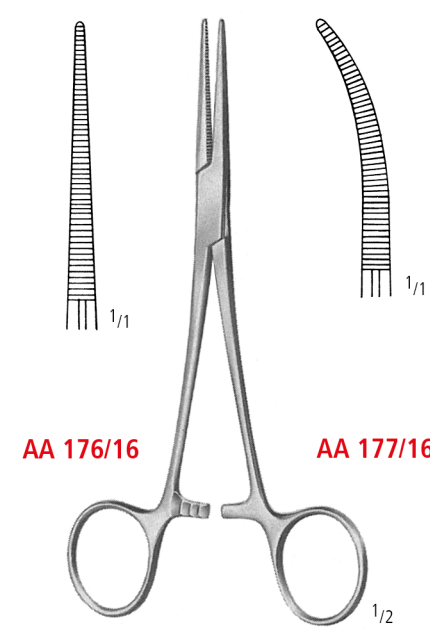

AA 176/16

AA 177/16

COLLER
 AA 176/14 14,0 cm/5 1/2" AA 177/14
 AA 176/16 16,0 cm/6 1/4" AA 177/16

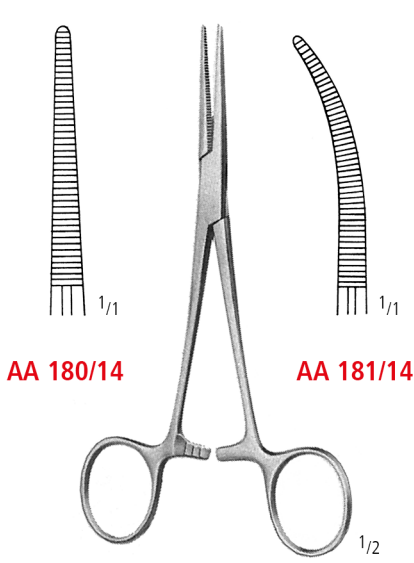

AA 180/14

AA 181/14

CRILE
 14,0 cm/5 1/2"

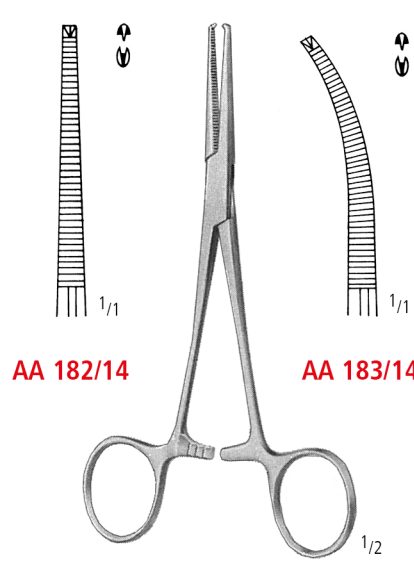

AA 182/14

AA 183/14

CRILE 1:2
 14,0 cm/5 1/2"

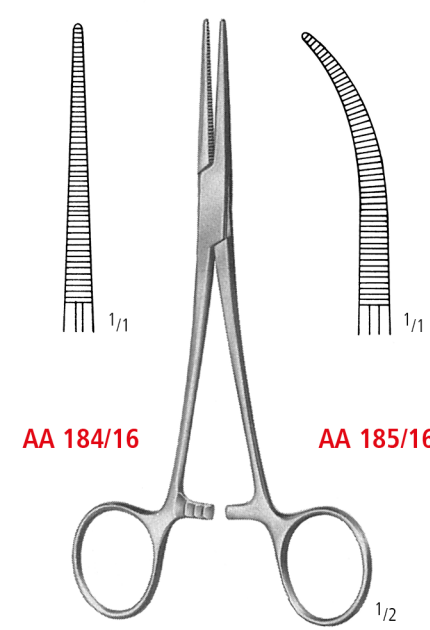

AA 184/16

AA 185/16

CRILE-RANKIN
 16,0 cm/6 1/4"

Arterienklemmen
 Artery Forceps
 Pinzas hemostáticas
 Pincés hémostatiques
 Pinze emostatiche

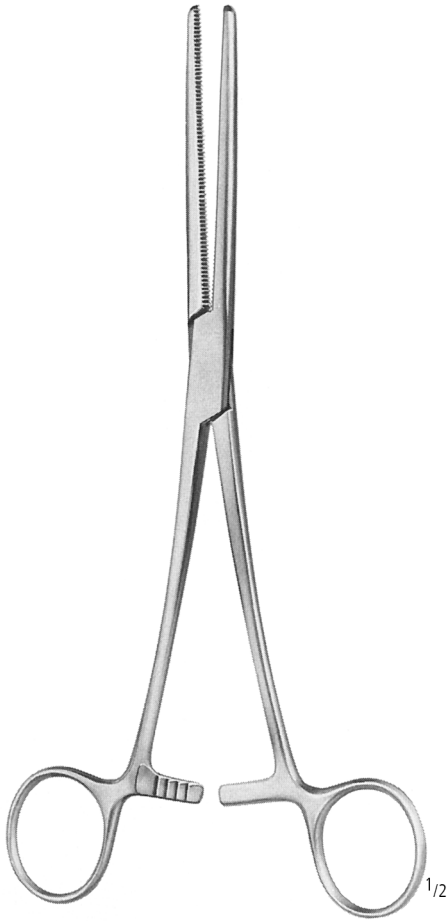

ROCHESTER-PEAN

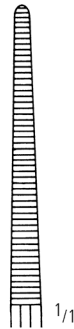

AA 200/14
 14,0 cm/5 1/2"

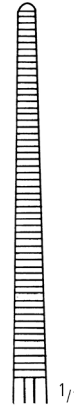

AA 200/16
 16,0 cm/6 1/4"

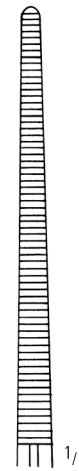

AA 200/18
 18,0 cm/7"

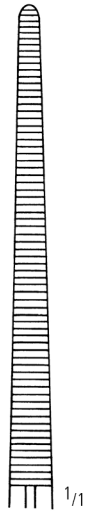

AA 200/20
 20,0 cm/8"

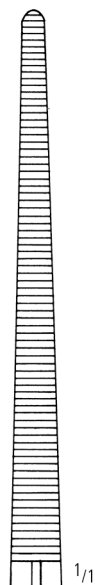

AA 200/22
 22,0 cm/8 3/4"

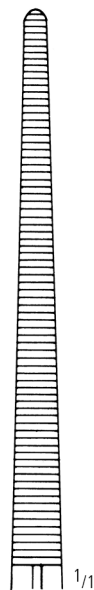

AA 200/24
 24,0 cm/9 1/2"

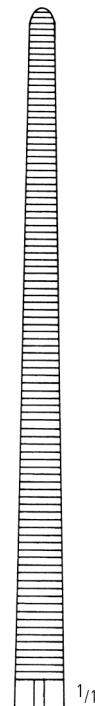

AA 200/26
 26,0 cm/10 1/2"

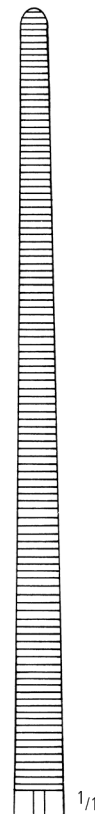

AA 200/30
 30,0 cm/12"

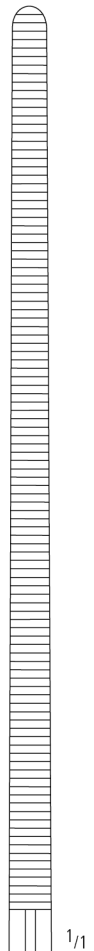

AA 200/36
 36,0 cm/14"